

Mars Exploration Rover

The Assembly Guide

billyhau.hk



1. Layout All the Parts

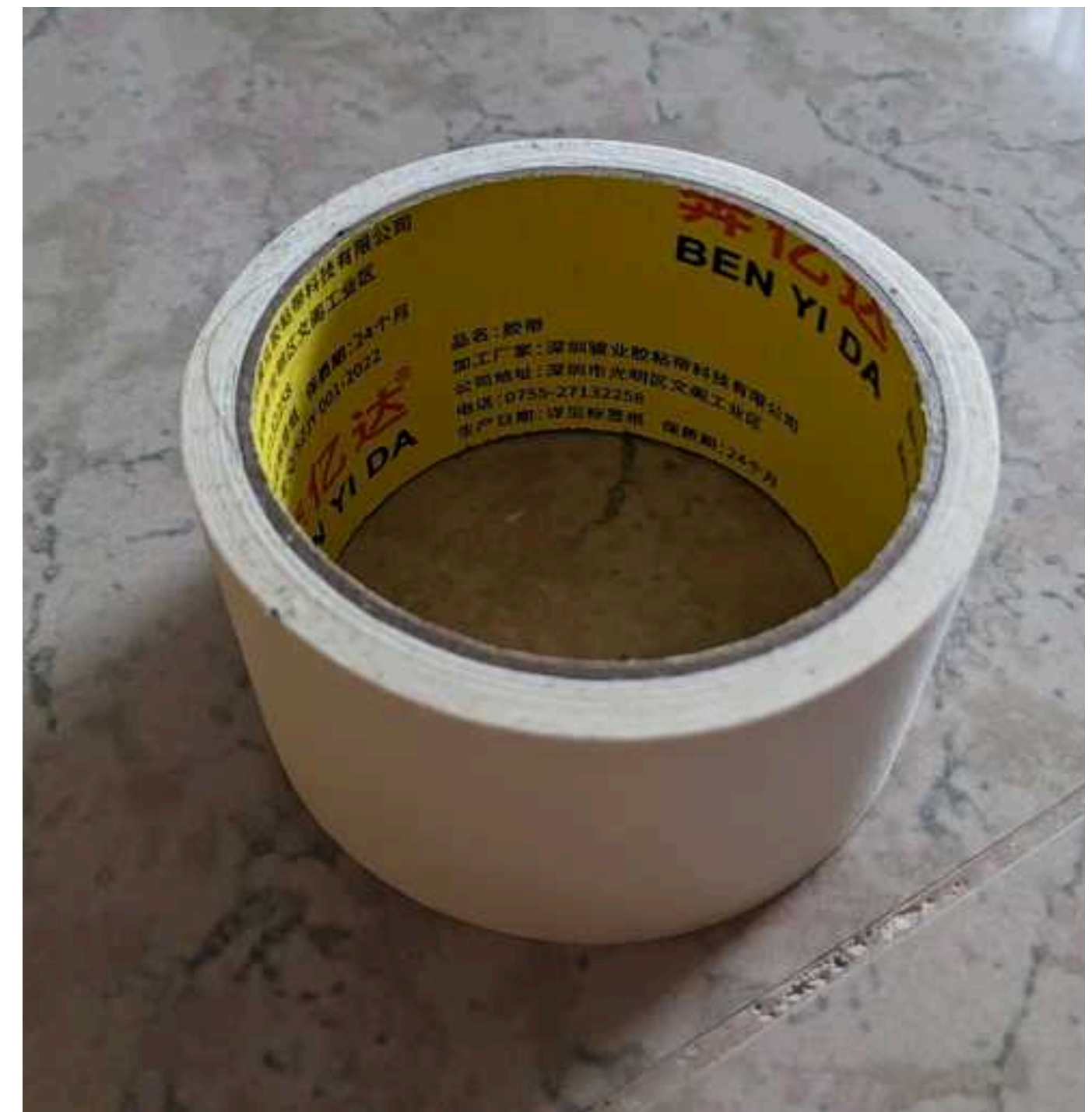
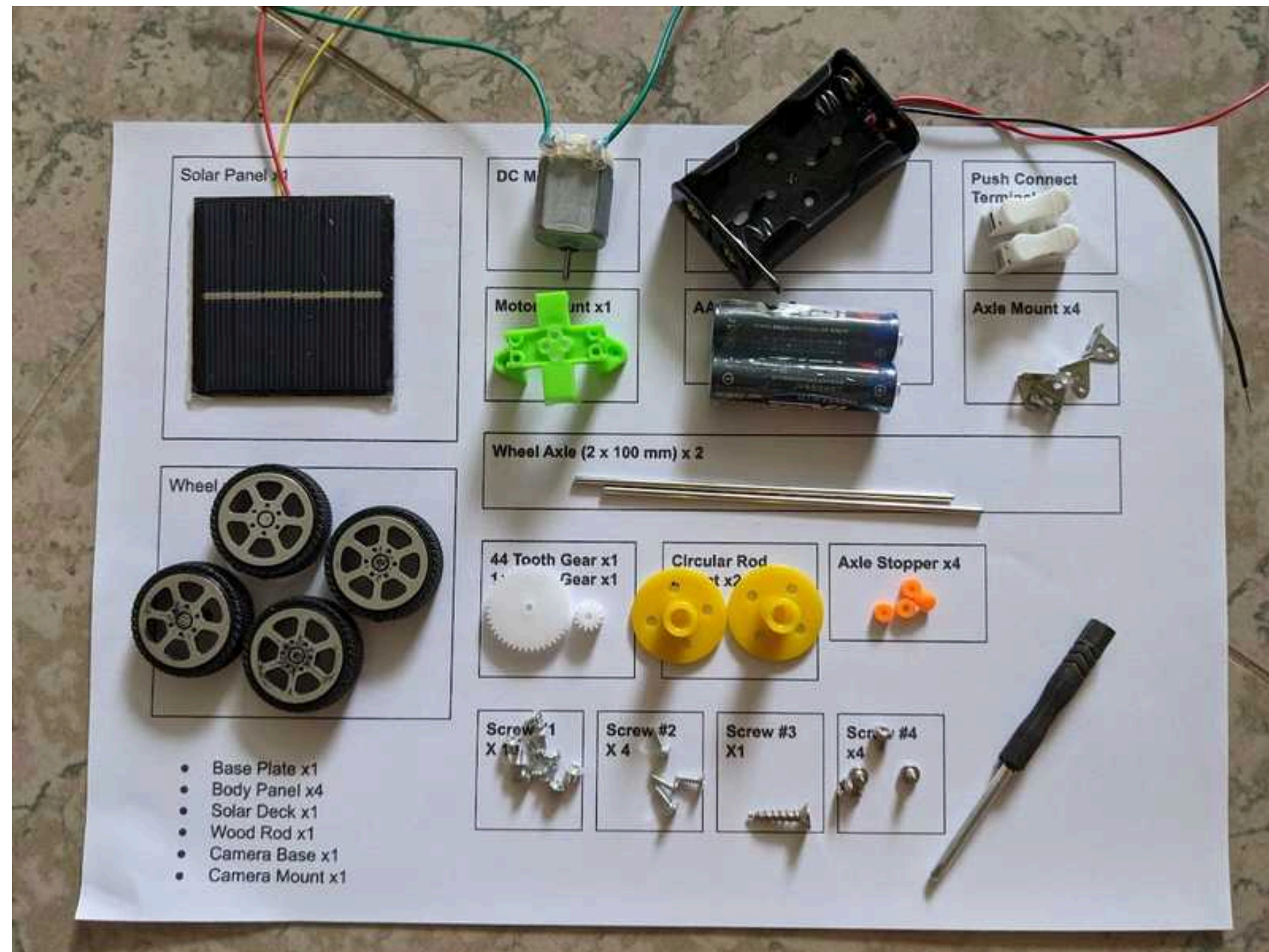



2) Attach the Axle Mount to Base Plate

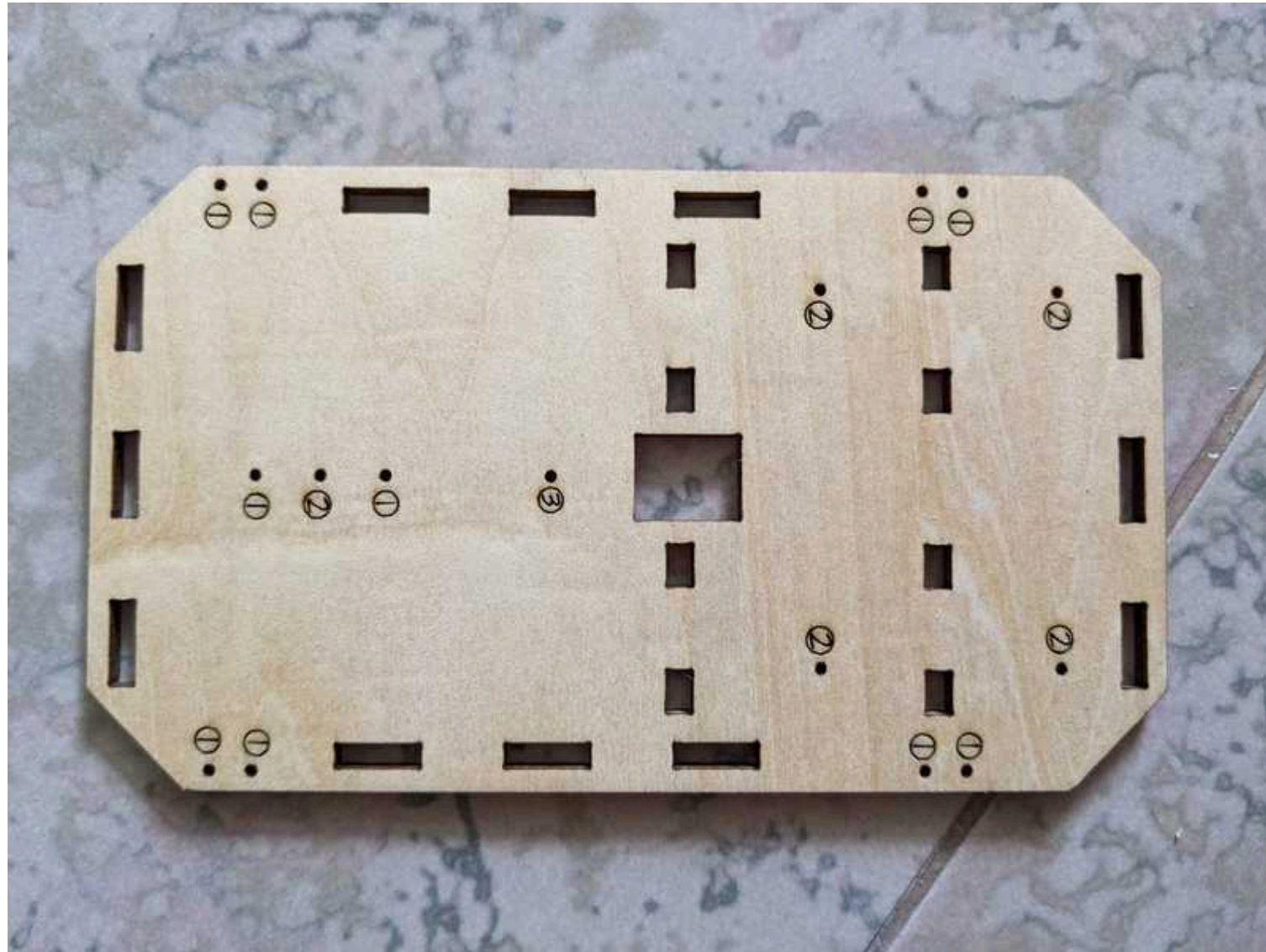

Flip
→

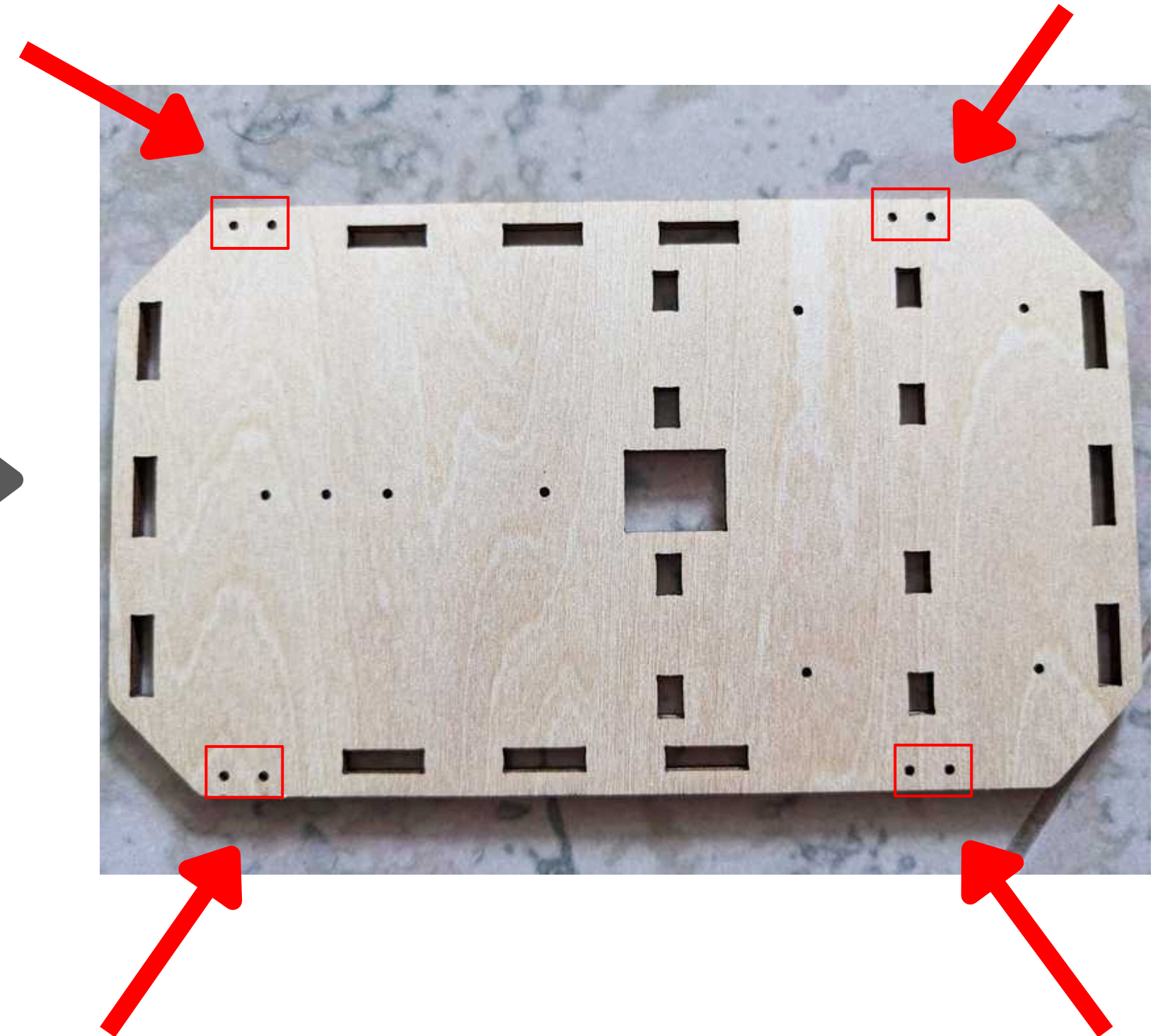



2) Attach the Axle Mount to Base Plate

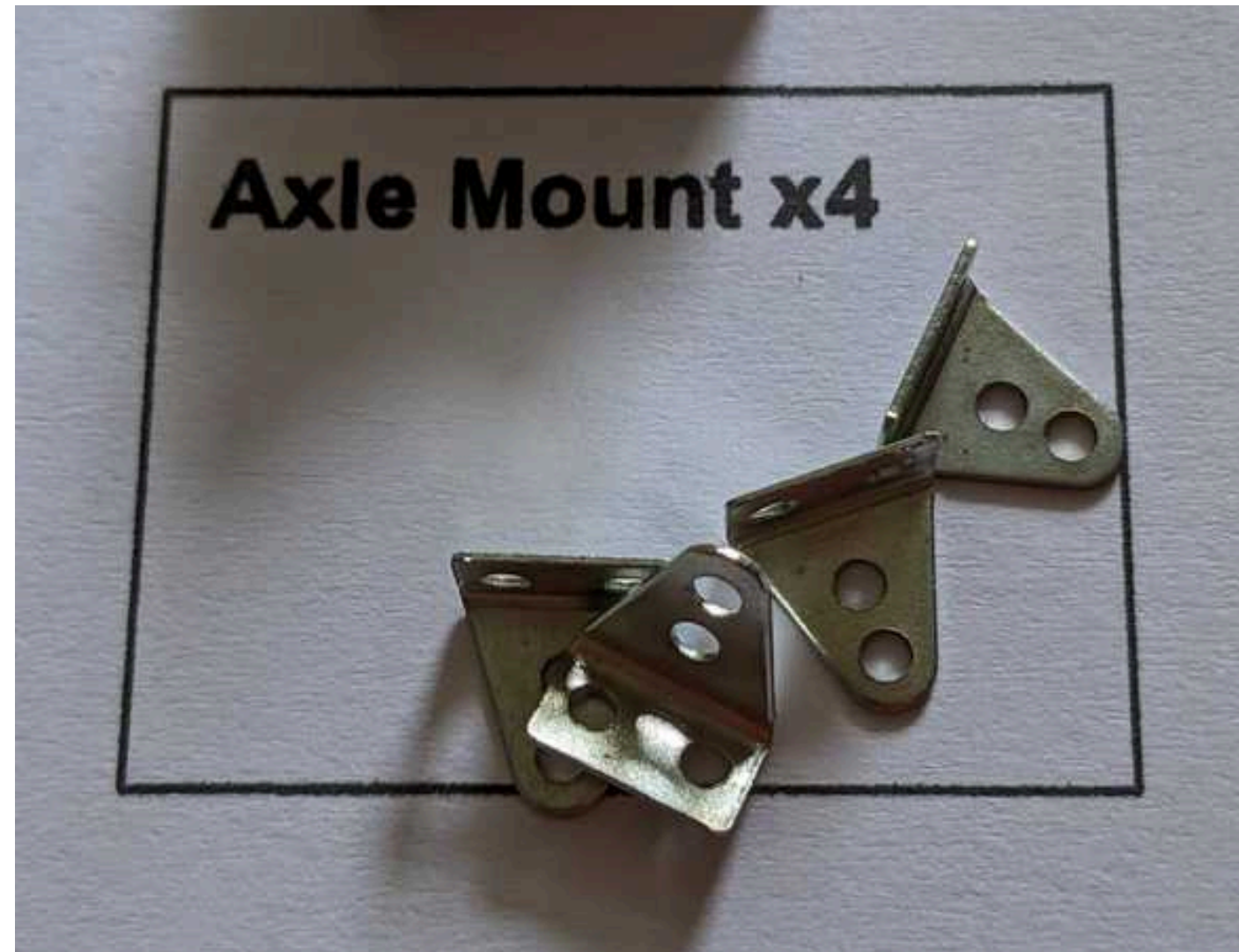



2) Attach the Axle Mount to Base Plate

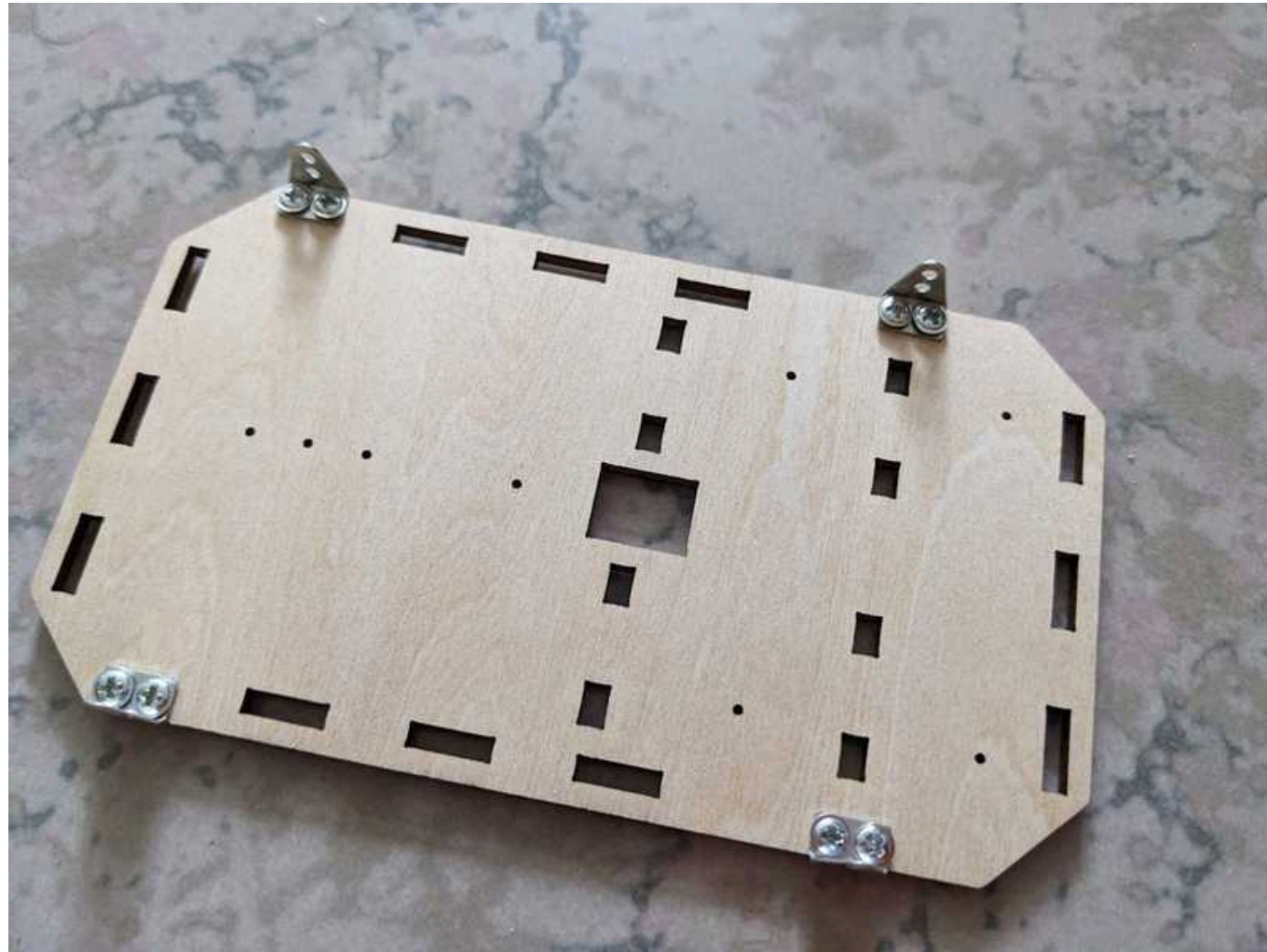

Take the screws and attach them to the axle mount first, and then screw them into the Base Plate





3) Attach Gear, Axle and Wheels

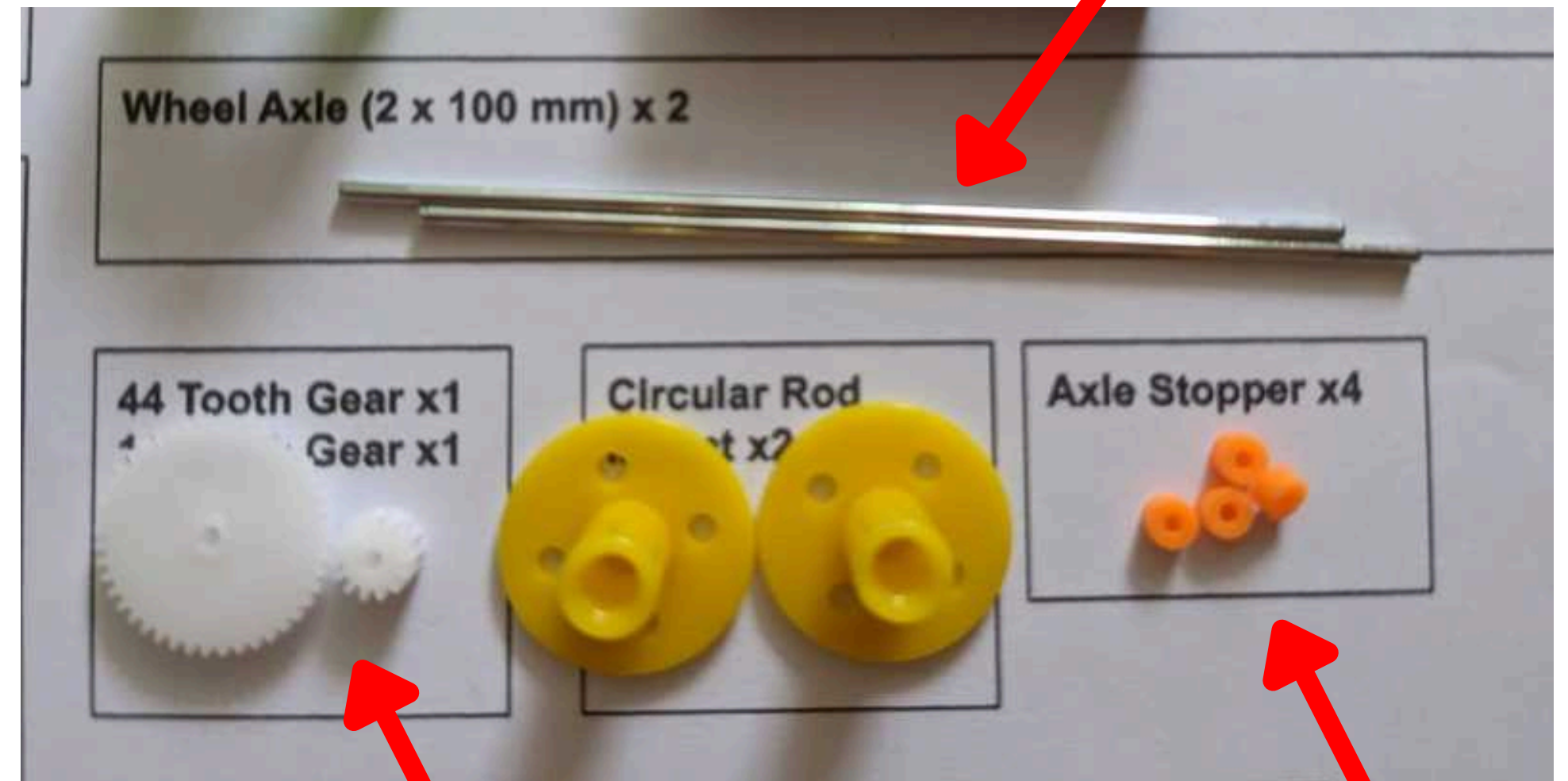



3) Attach Gear, Axle and Wheels

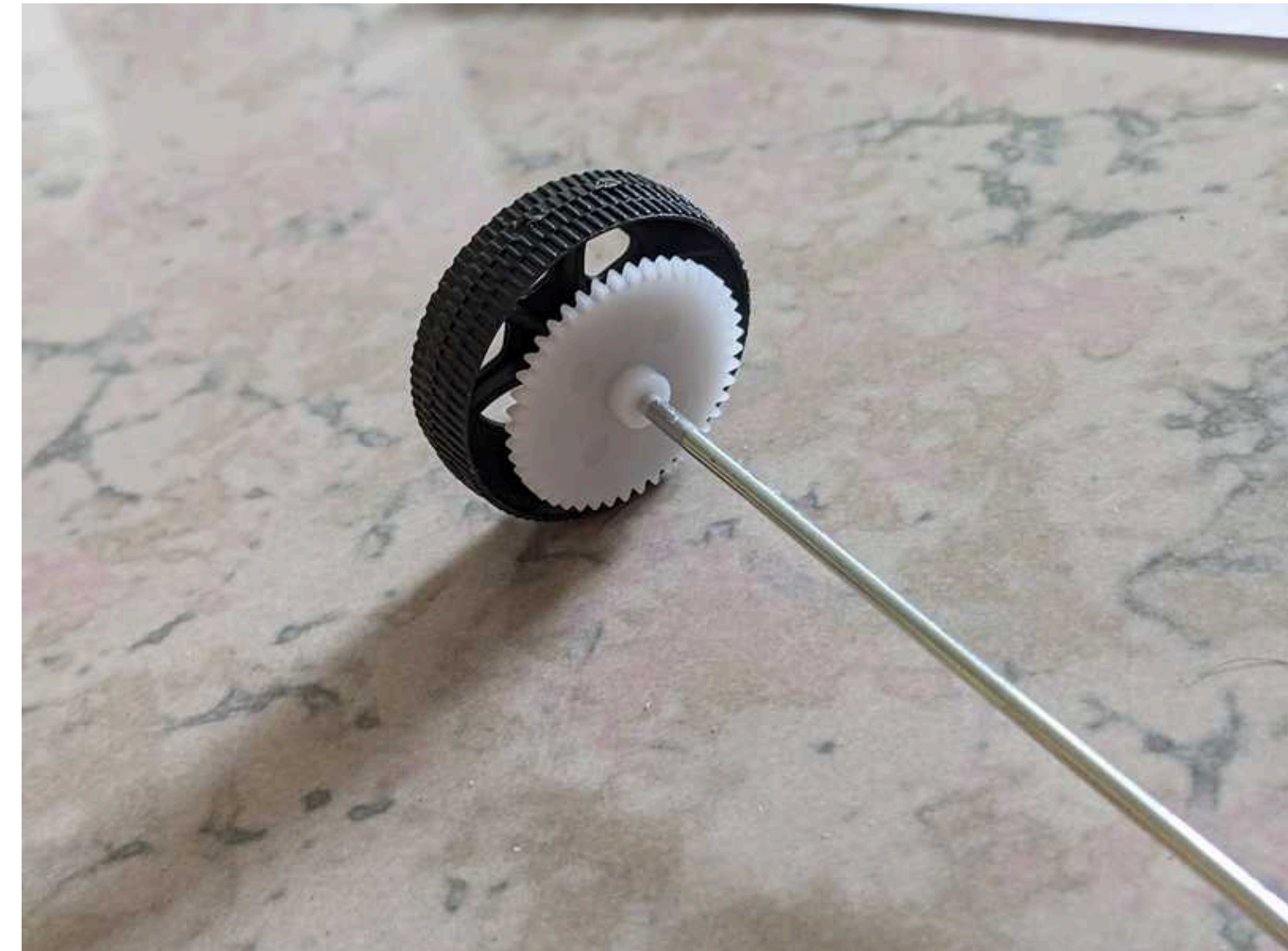



3) Attach Gear, Axle and Wheels

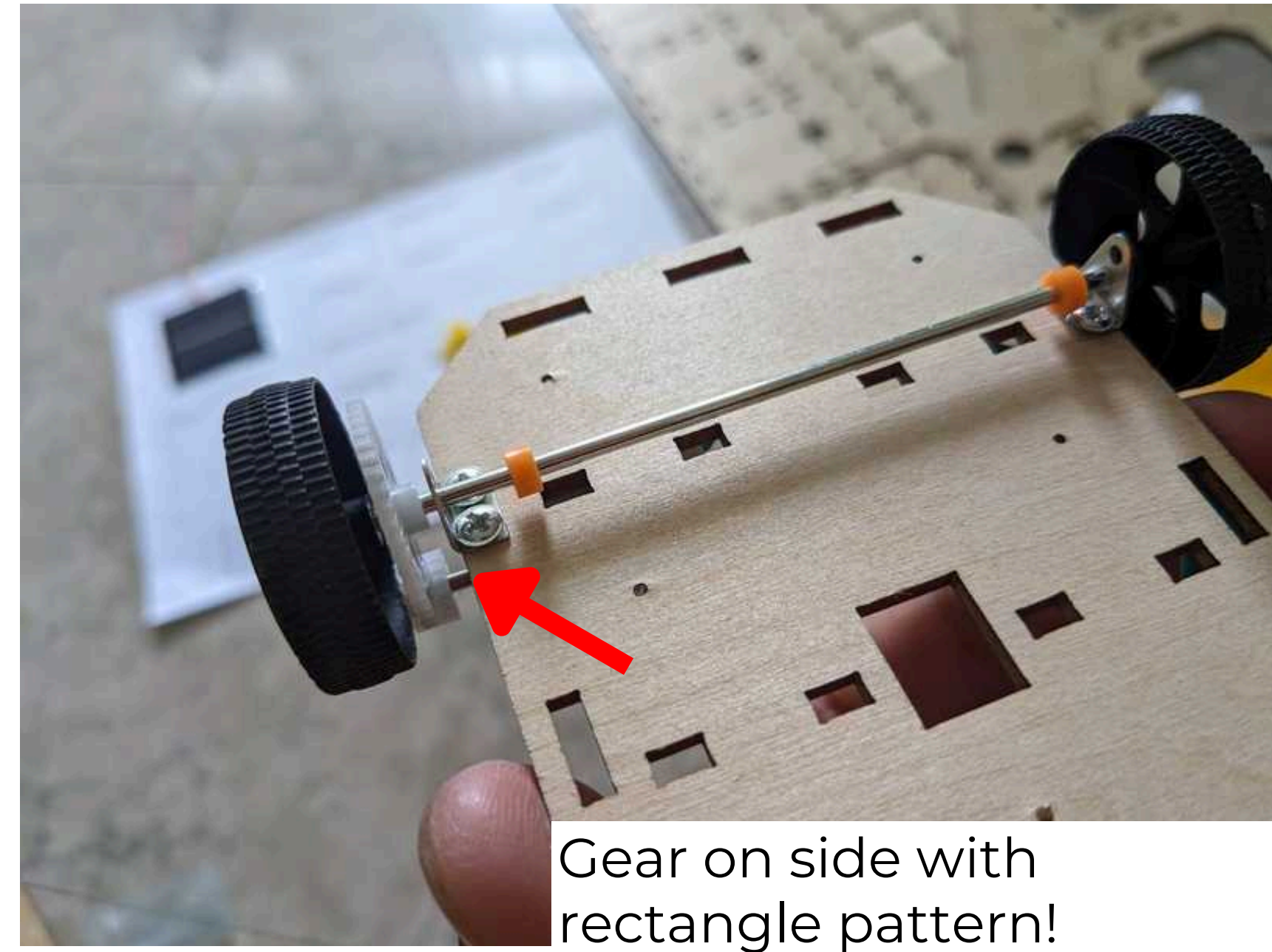



3) Attach Gear, Axle and Wheels

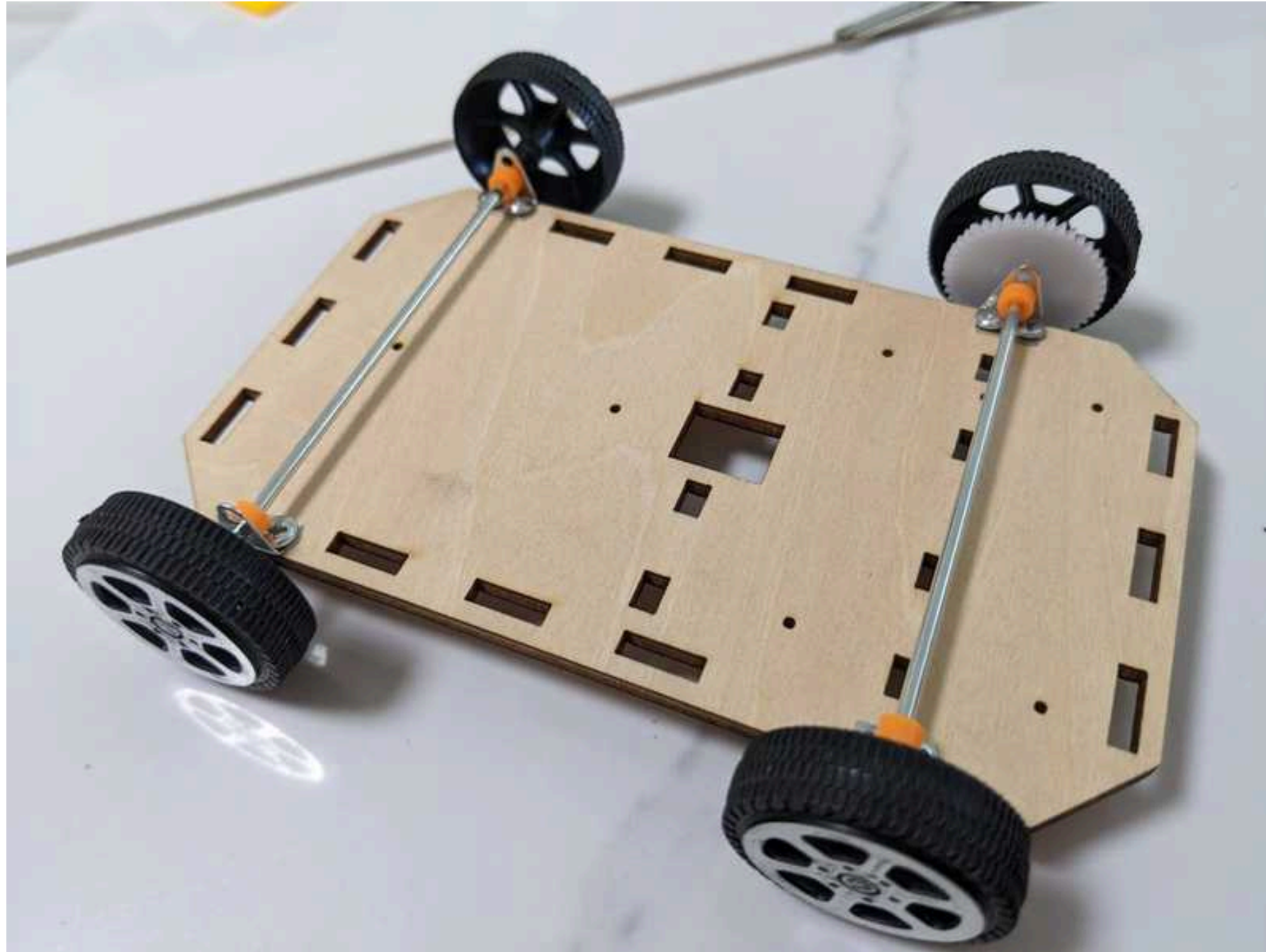

Make sure that the rover and move smoothly! If not, adjust the orange stoppers, they might be jammed with the screws.

4) Power and Mobility

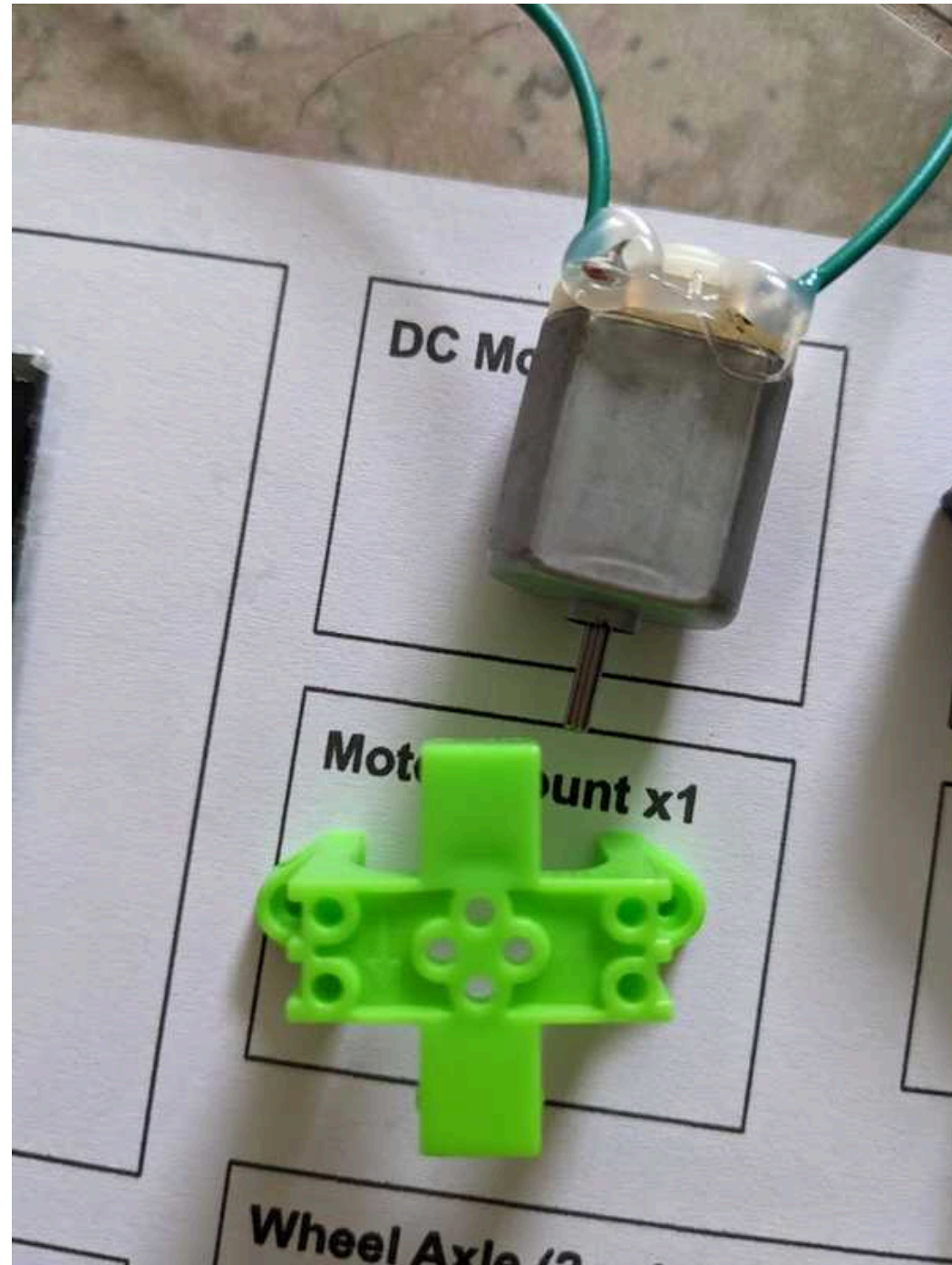



4) Power and Mobility

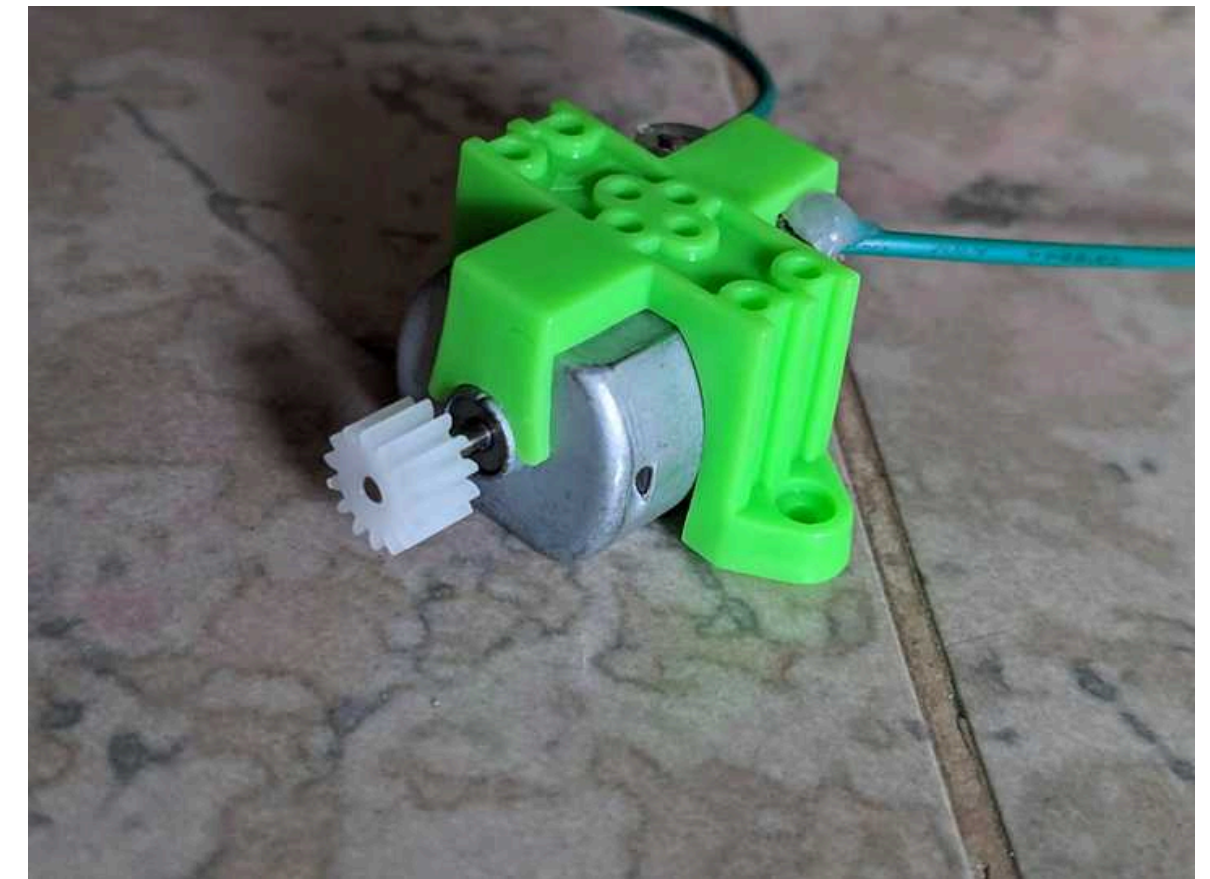
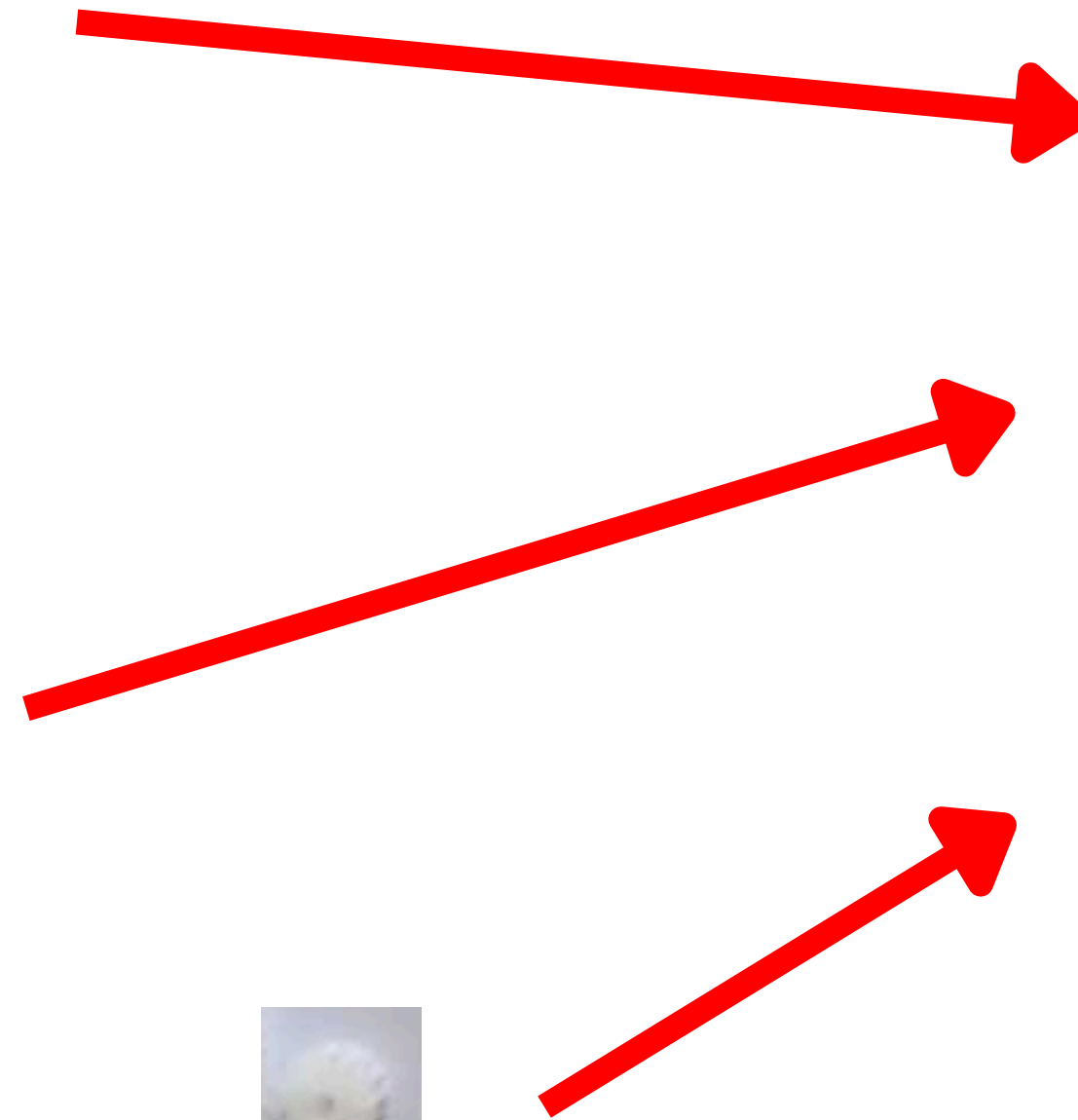
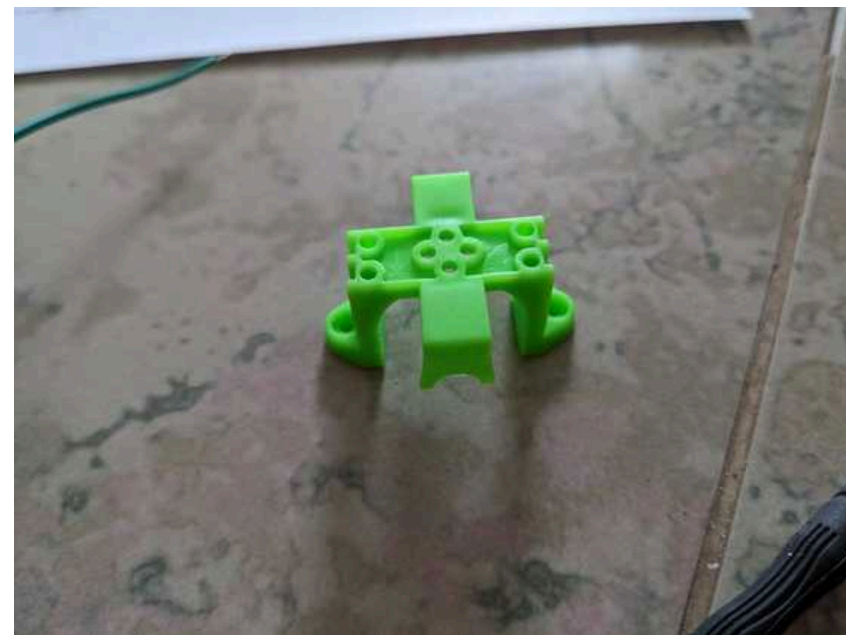



4) Power and Mobility

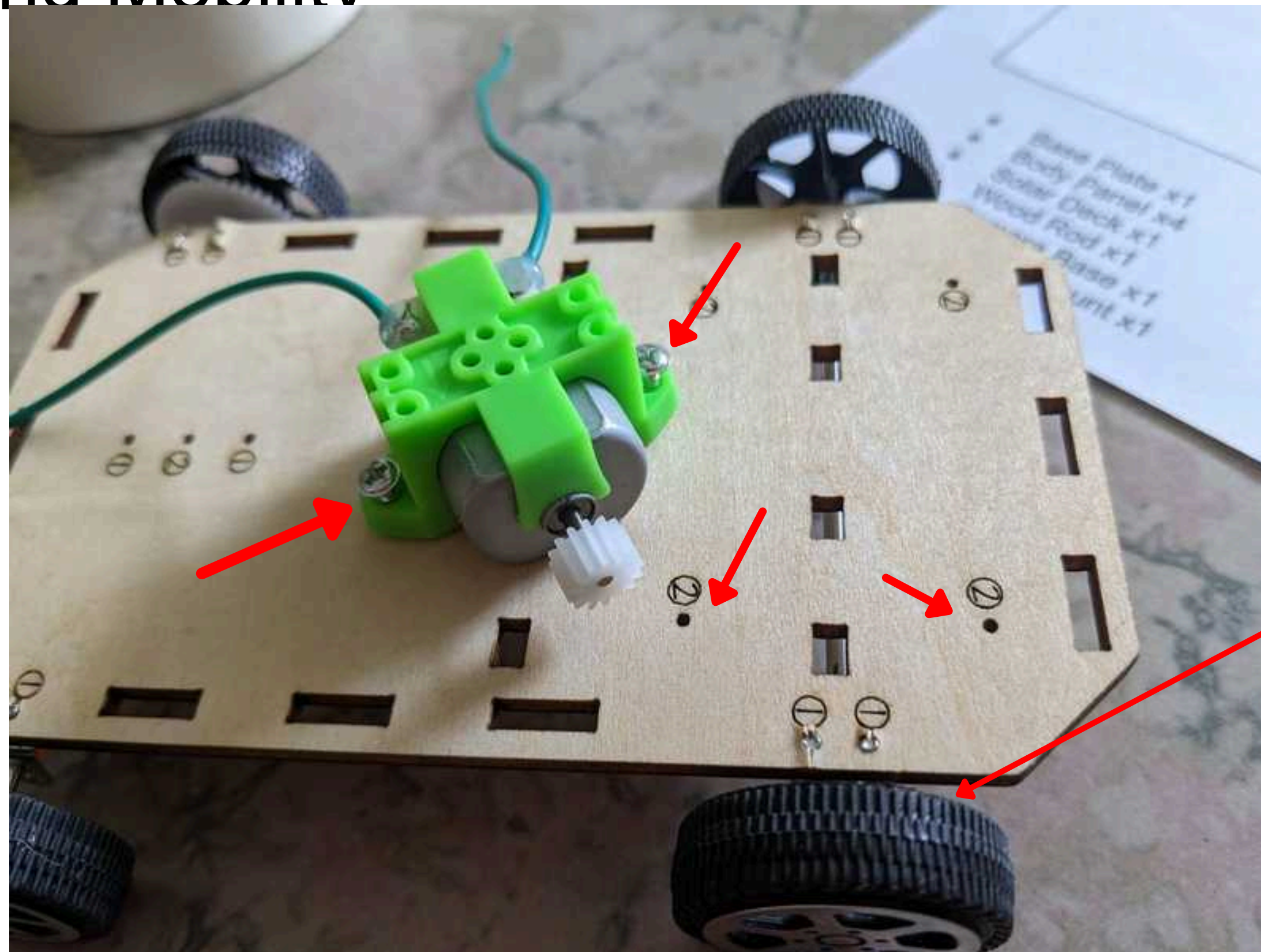

Make sure the motor is mounted where the geared wheel is! Else the rover can't move, like this!



4) Power and Mobility

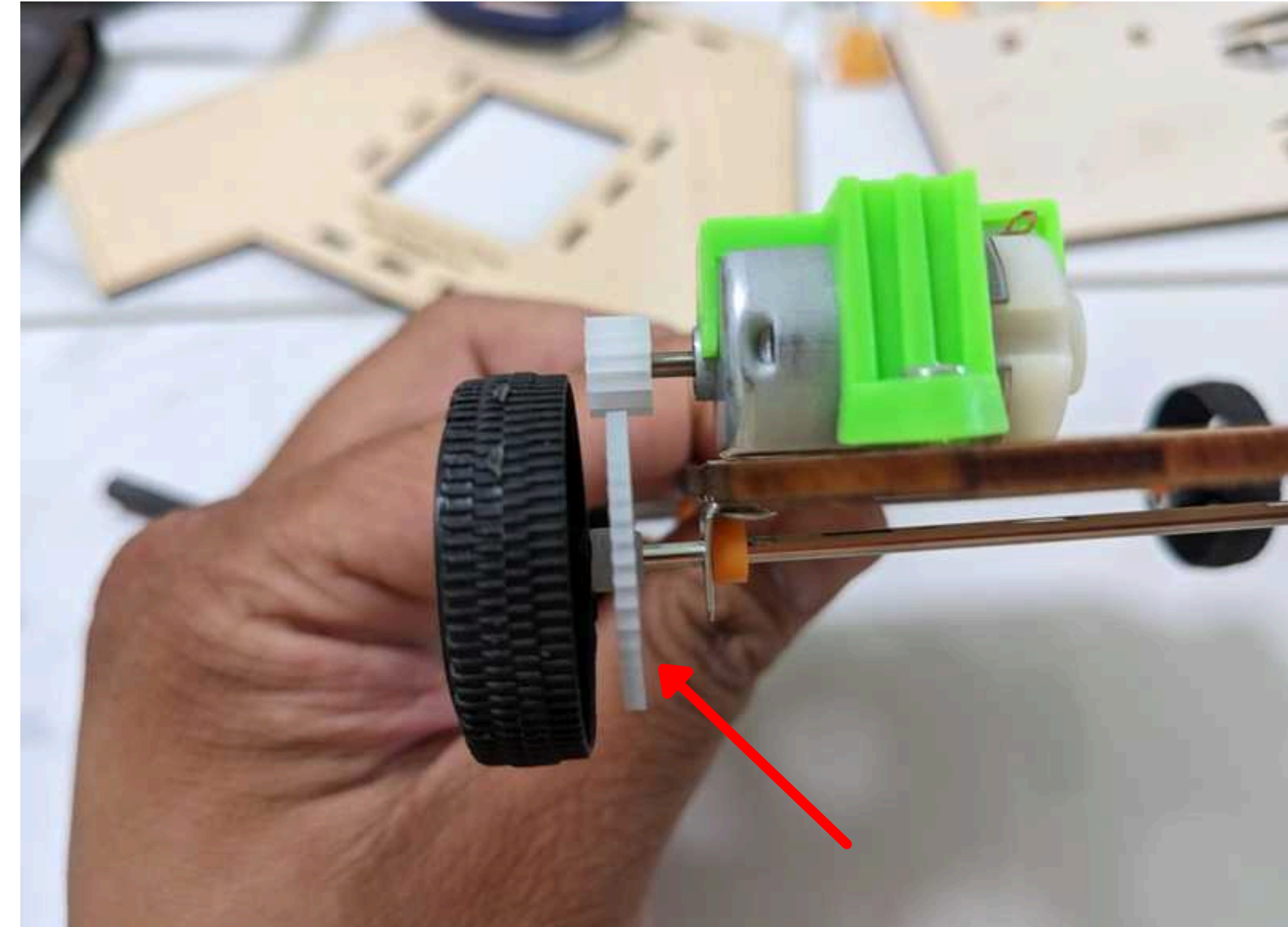
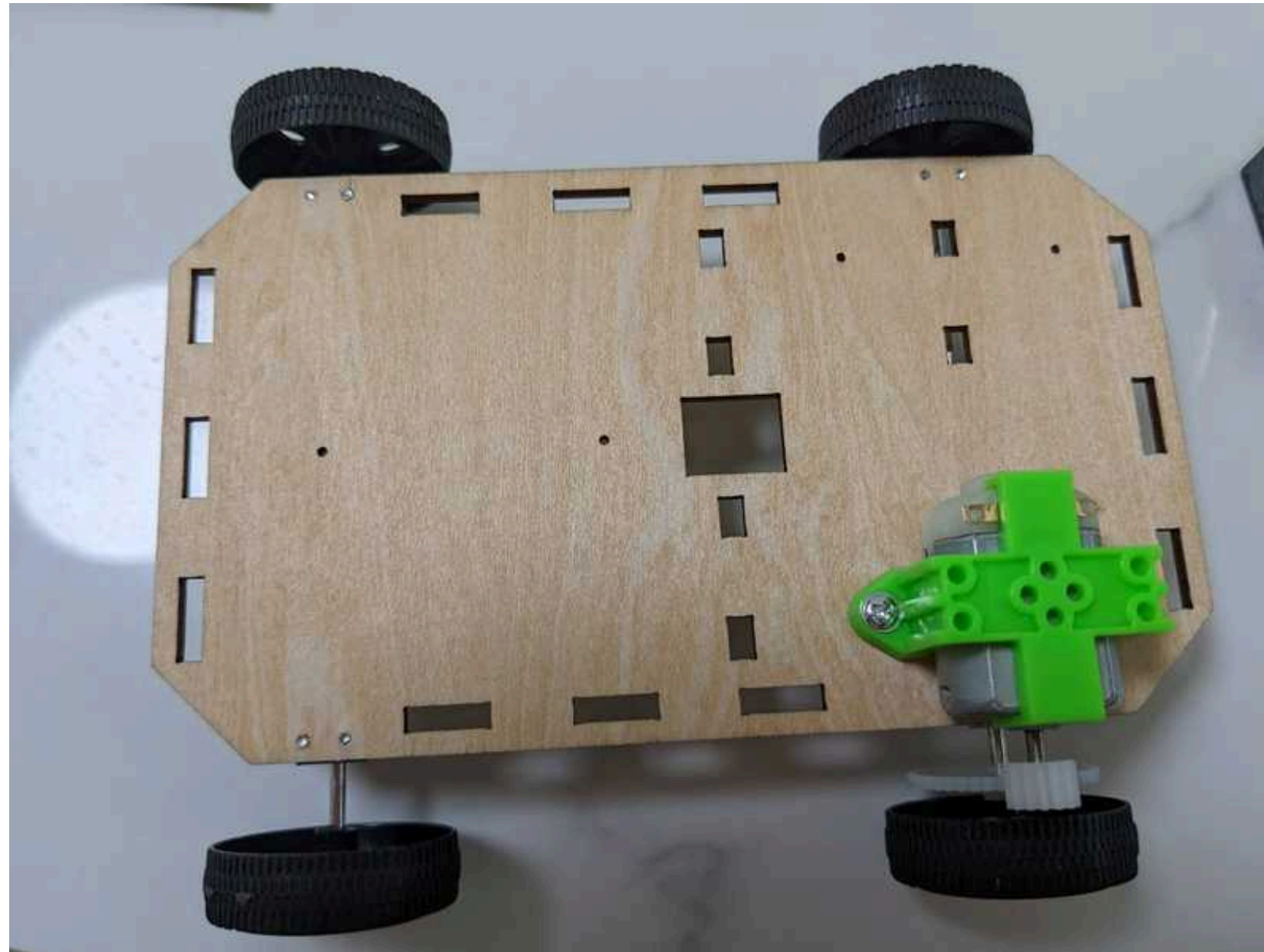



4) Power and Mobility

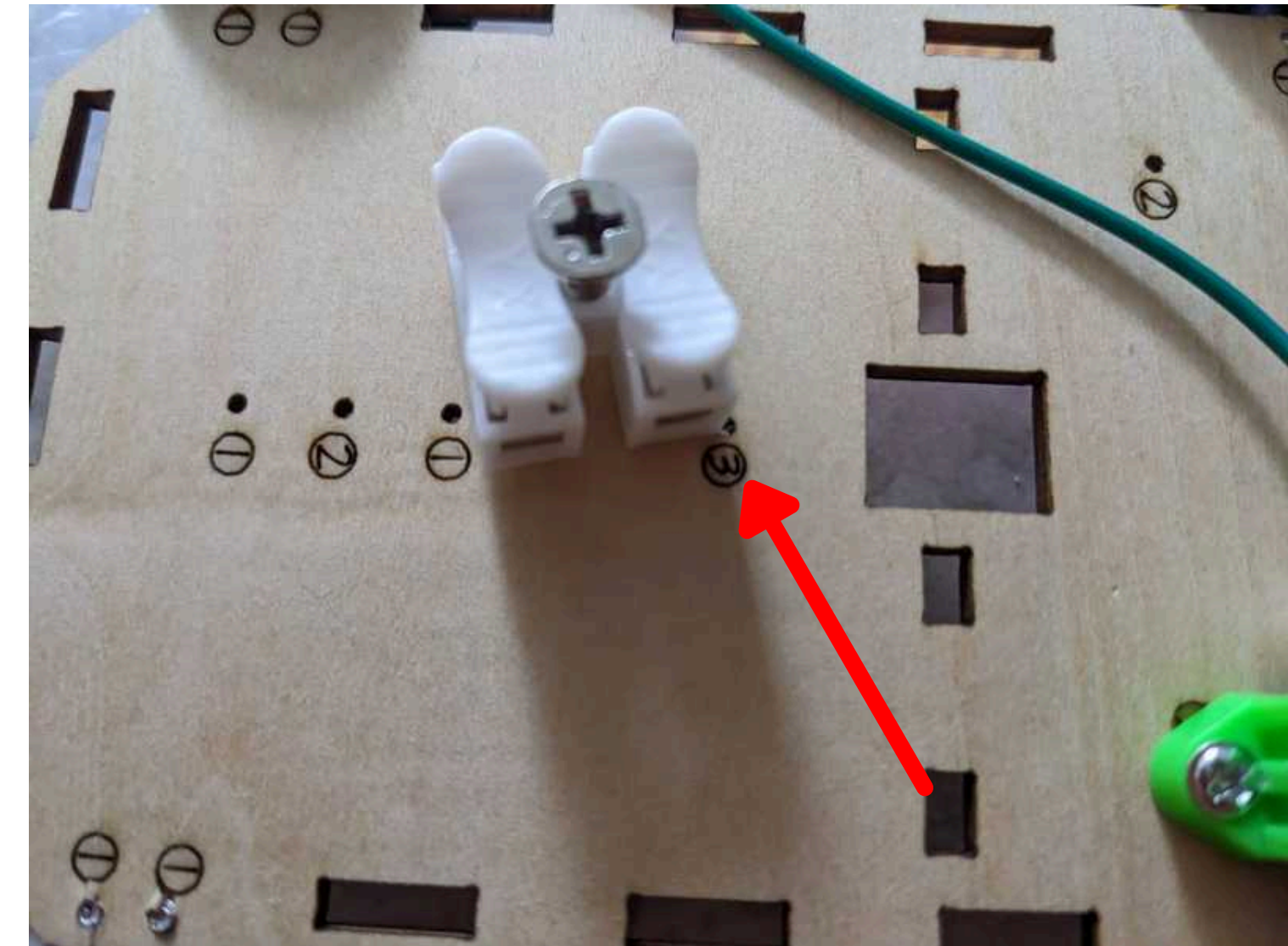
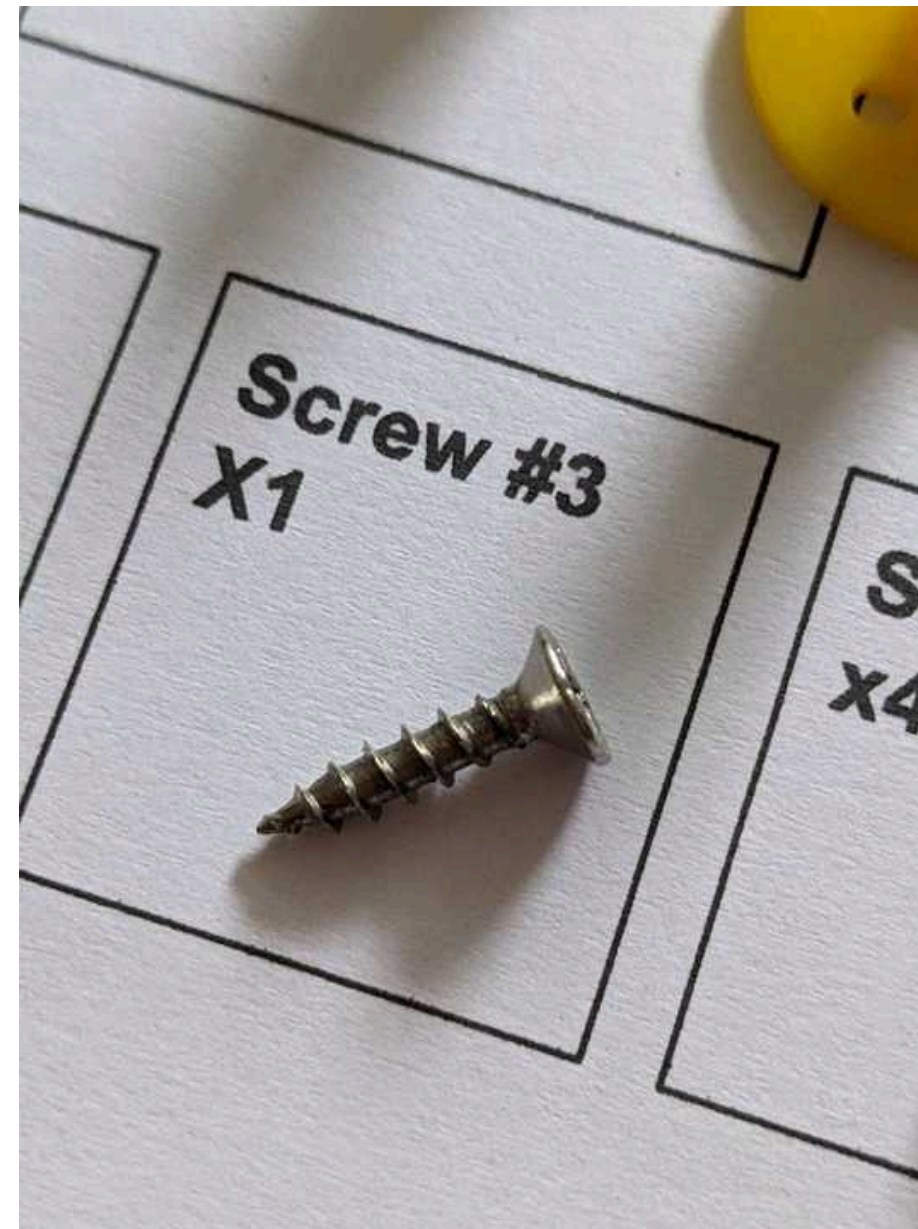
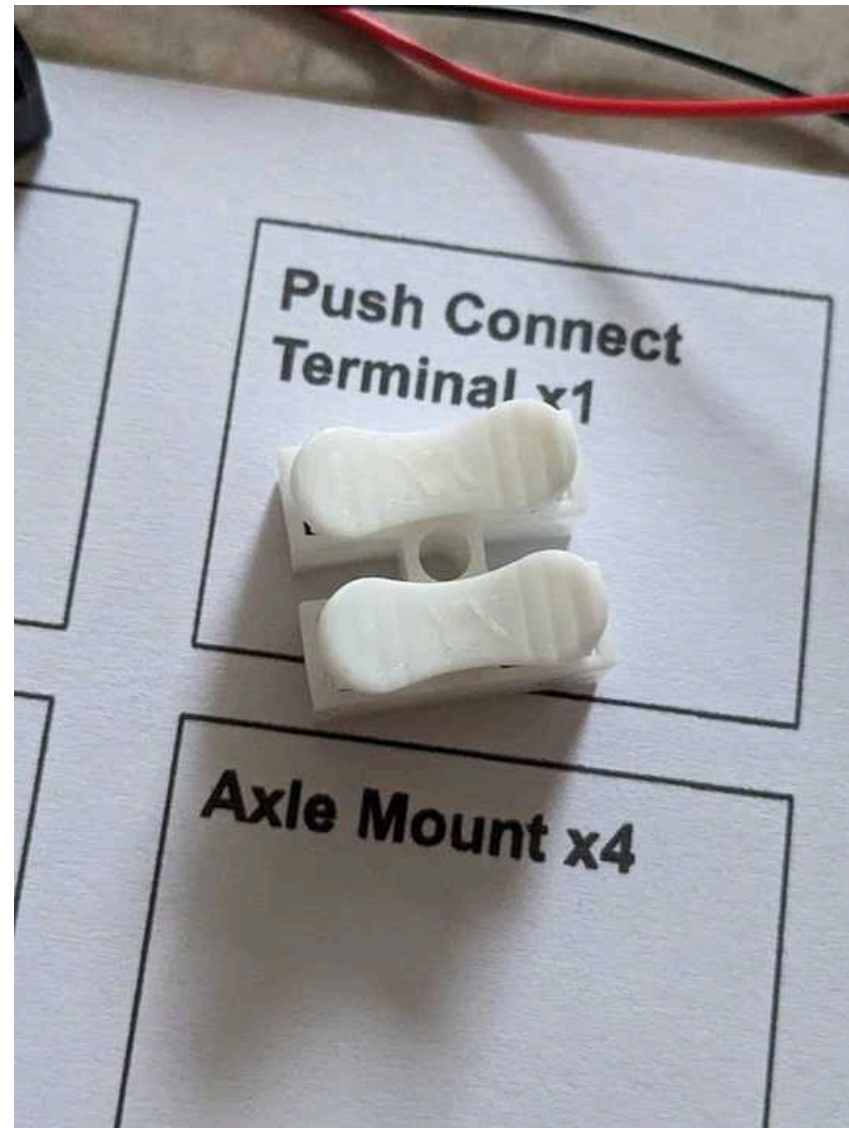



4) Power and Mobility

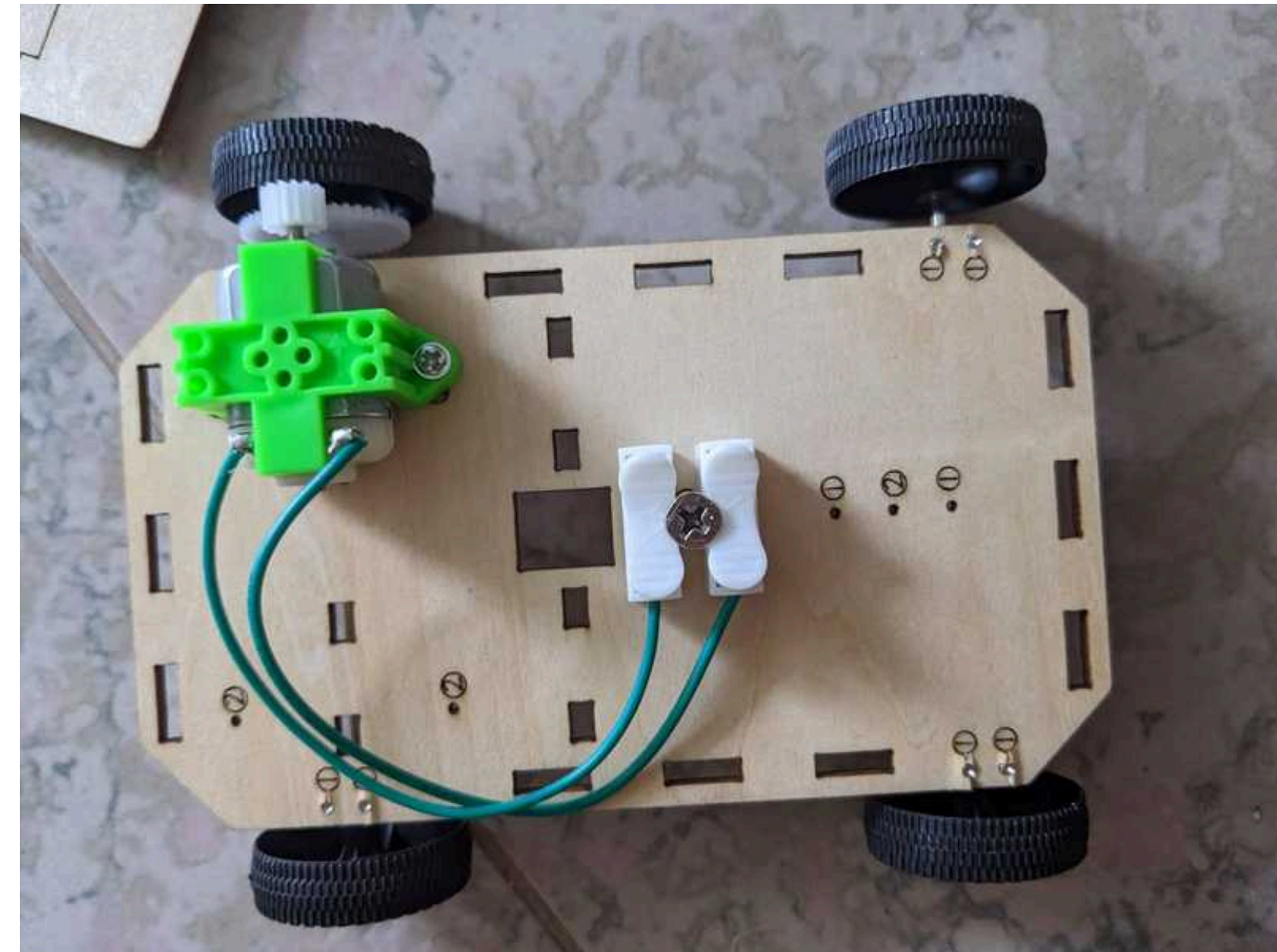
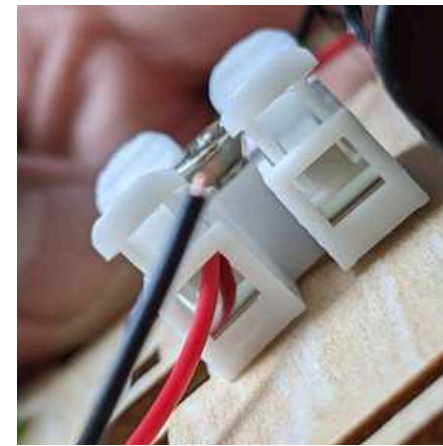
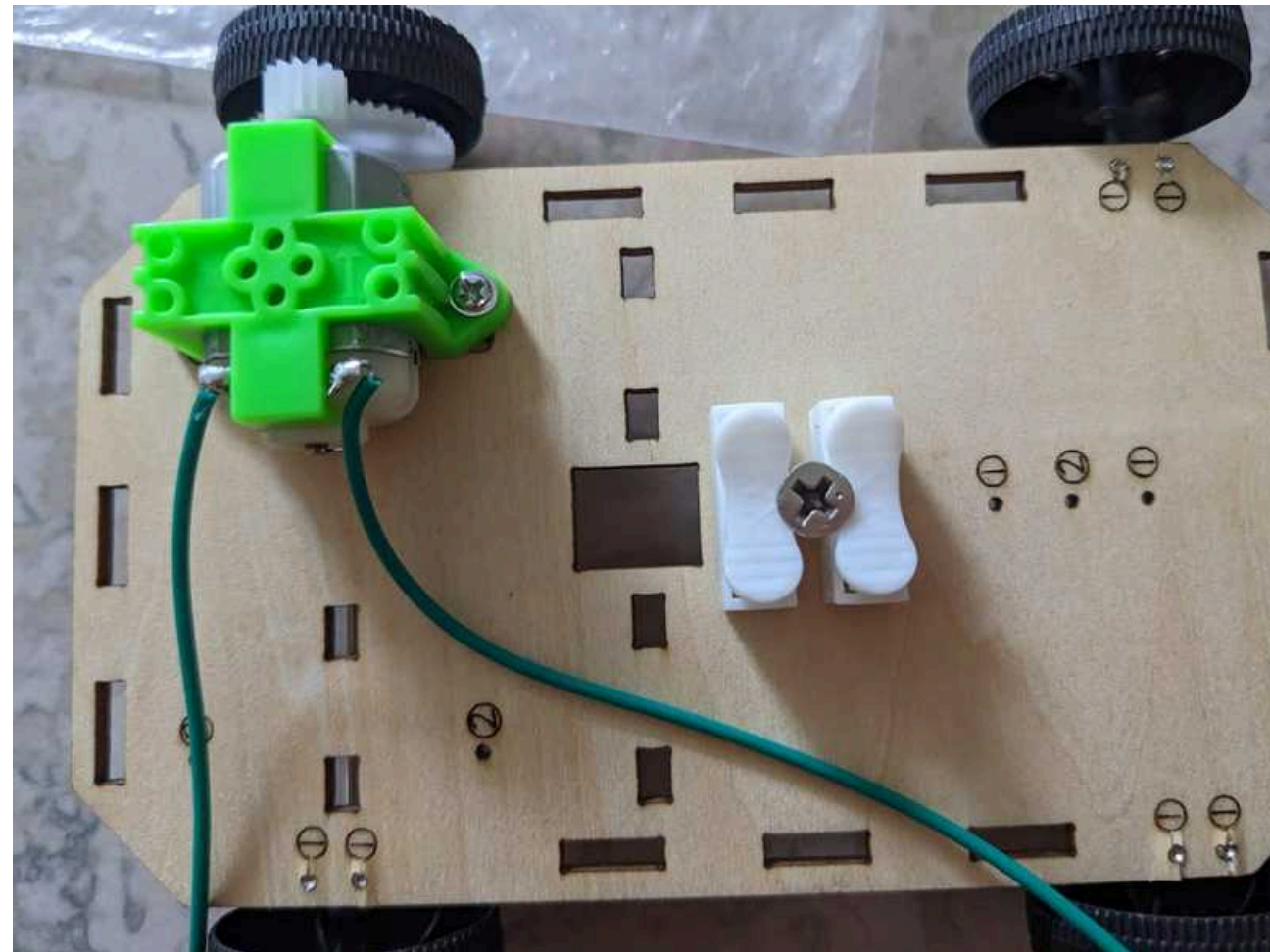

Push the terminal and connect the wires. Make sure that the metal portion of the wire is in contact with the metal clip!



4) Power and Mobility

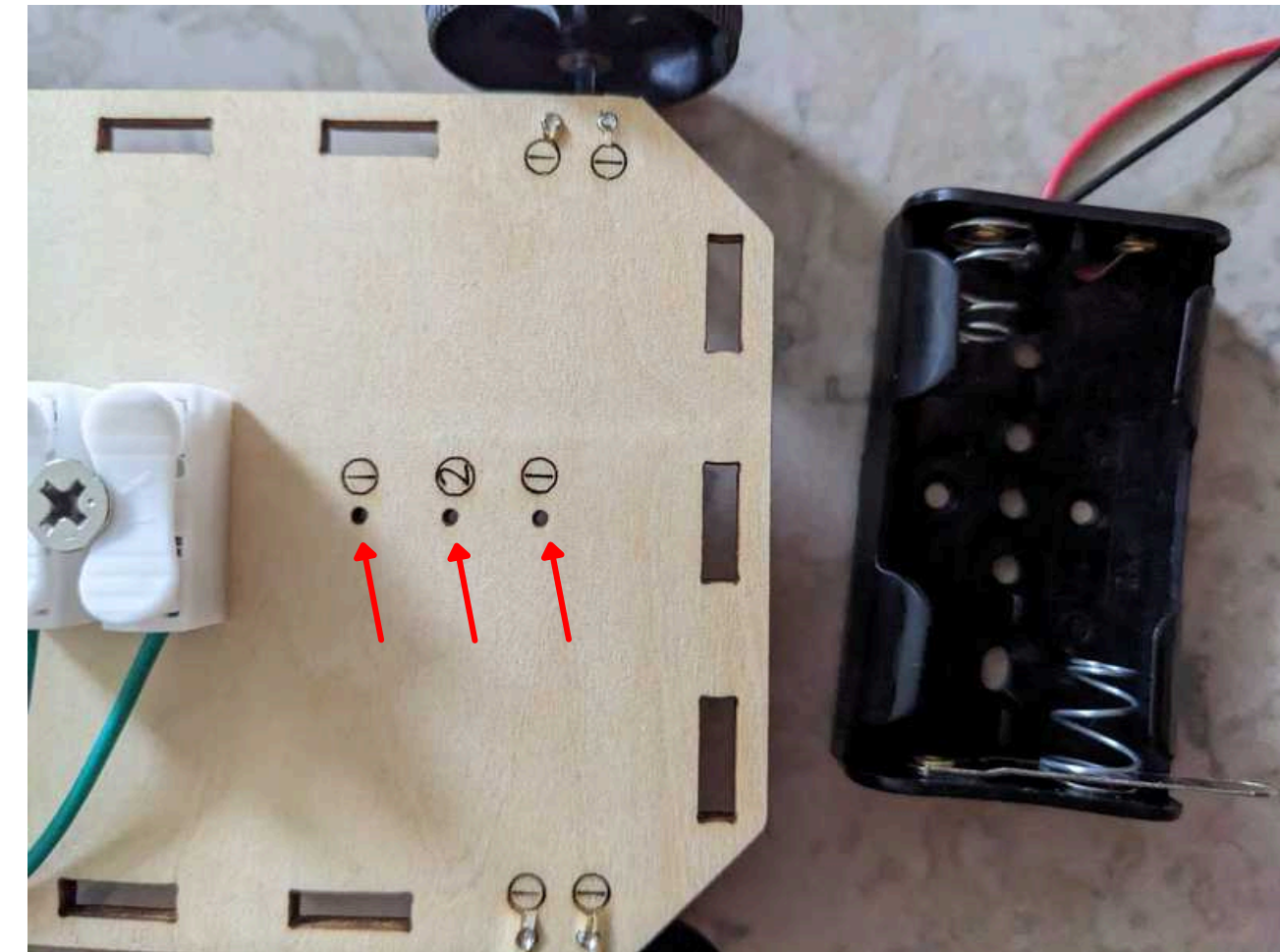
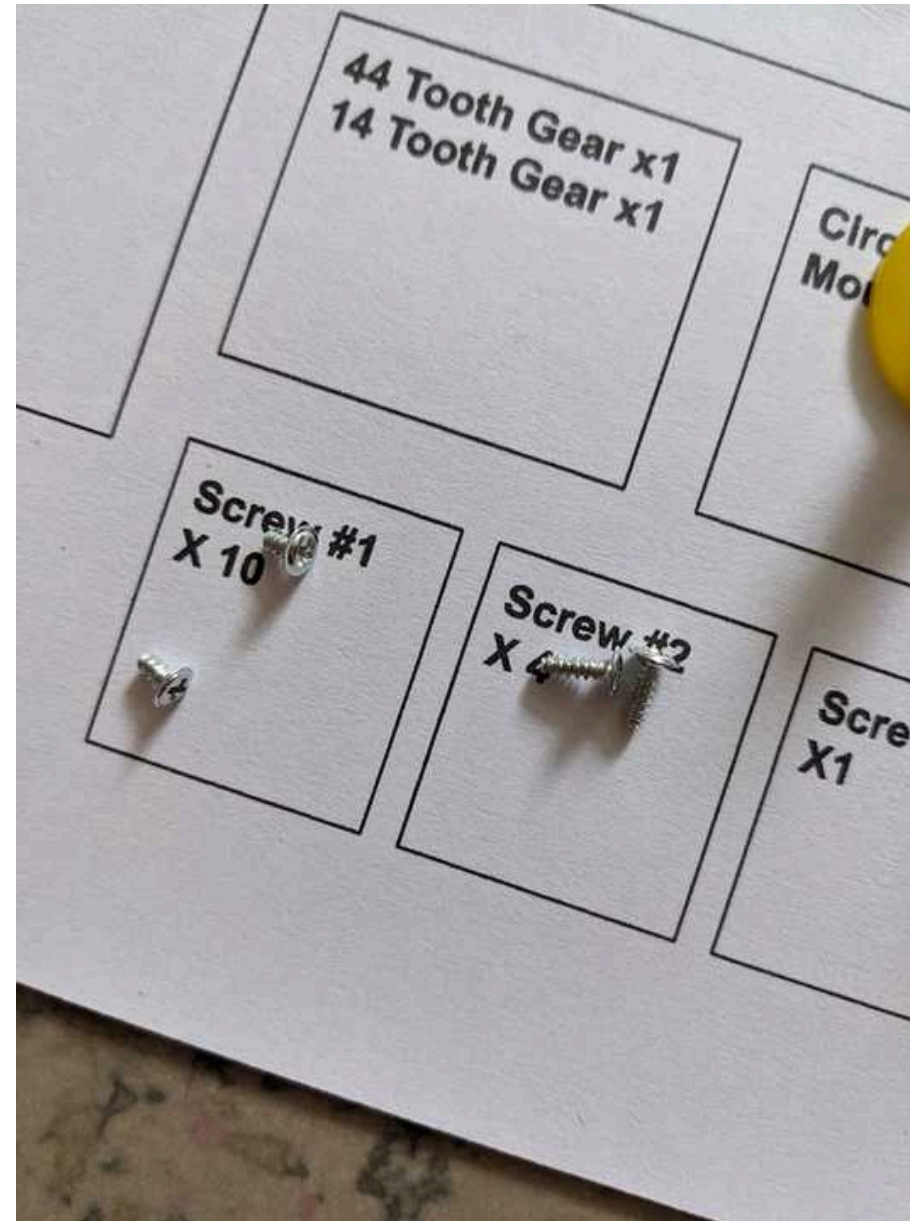
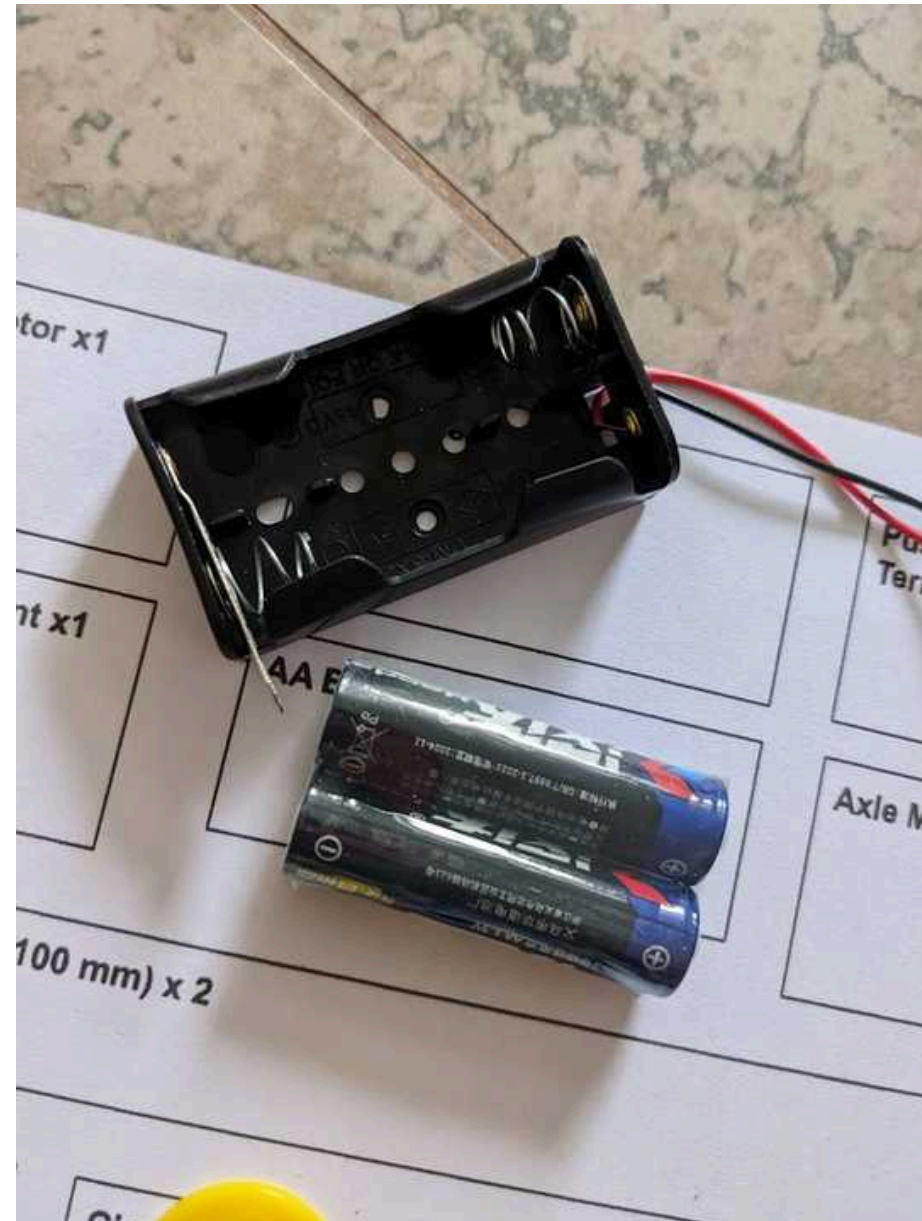

4) Power and Mobility



BILLY HAU
MAKER | GAME DEV | EDUCATOR





4) Test Drive

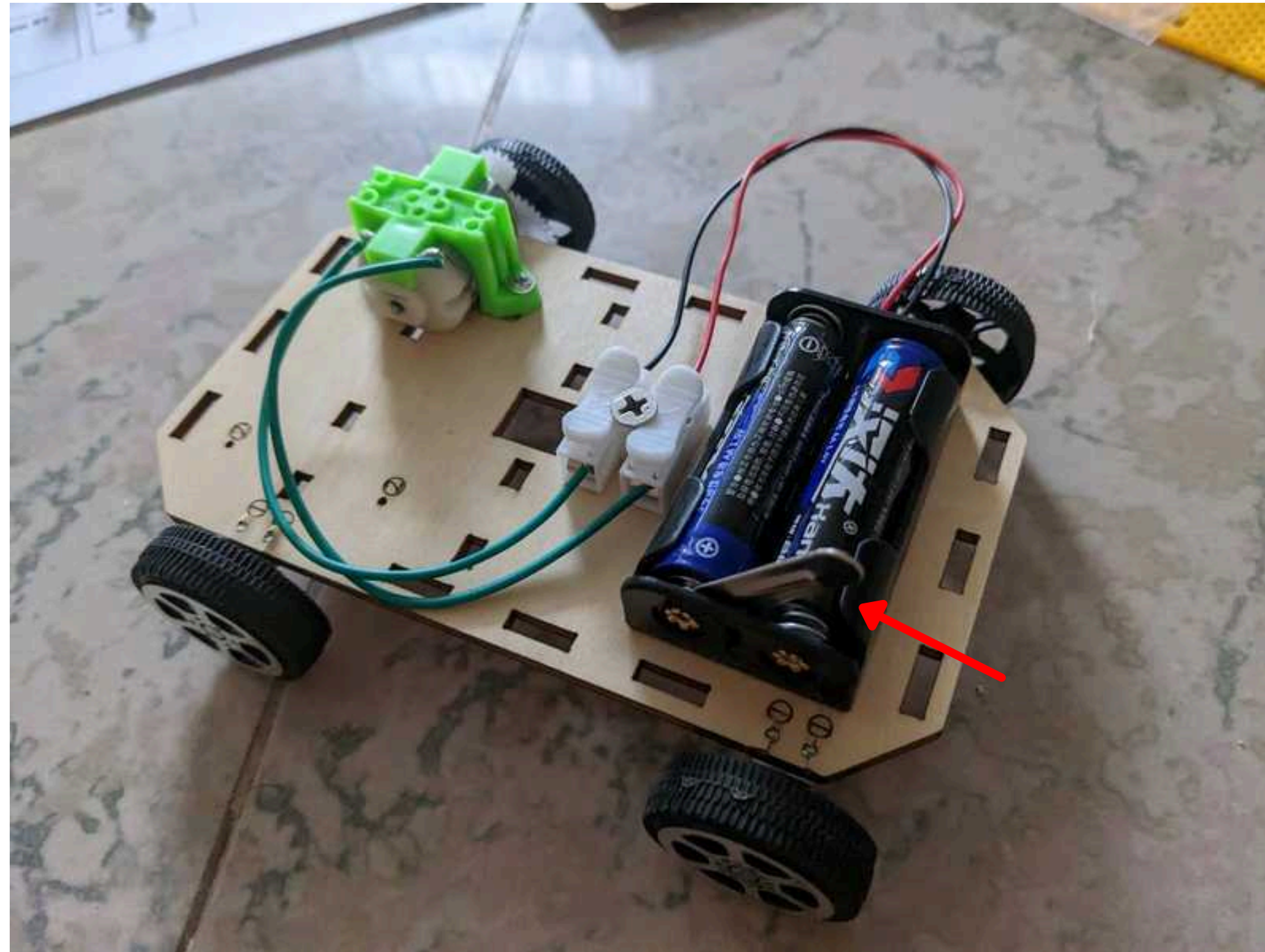

Flip the switch, and the motor and wheels should spin! If not, check if something is jammed, like the orange stopper, the gears...

This rover is front wheel drive, check to see if the rover is moving with the motor's direction forward. **Reverse the battery's red and black wires to reverse motor direction!**

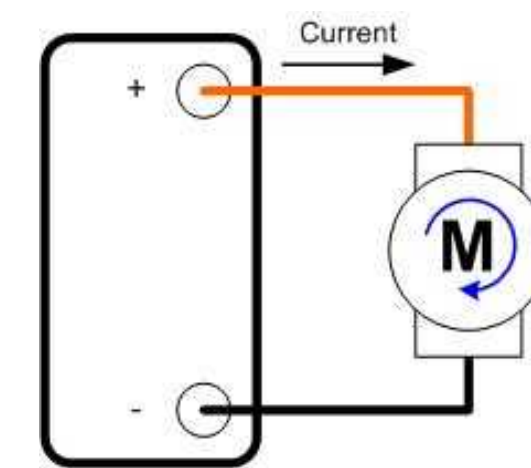

Positive Polarity
Clockwise rotation

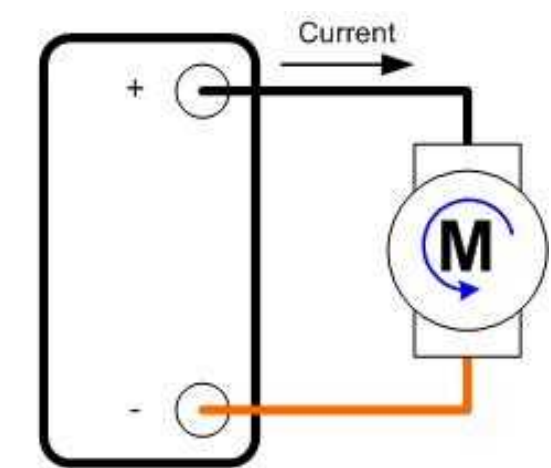

Negative Polarity
Counter - Clockwise rotation



5) Install Body Panels

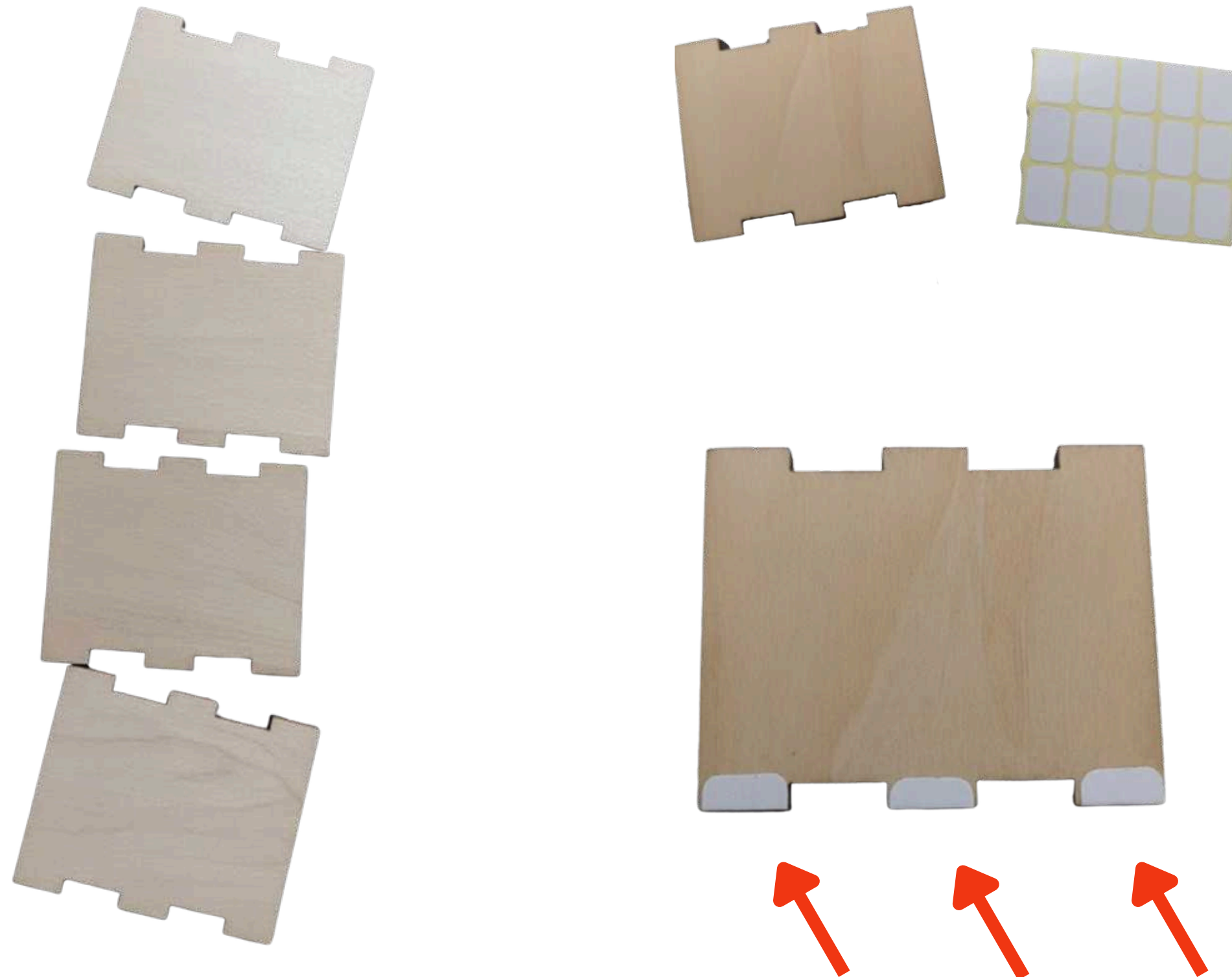

To assemble the body panels, we could use glue, but that's messy and slow. A faster way is to use interference fitting. We will add a little bit of tape to the legs on the bottom of the body panels.

When we insert this to the Base Plate, it will fit tightly!

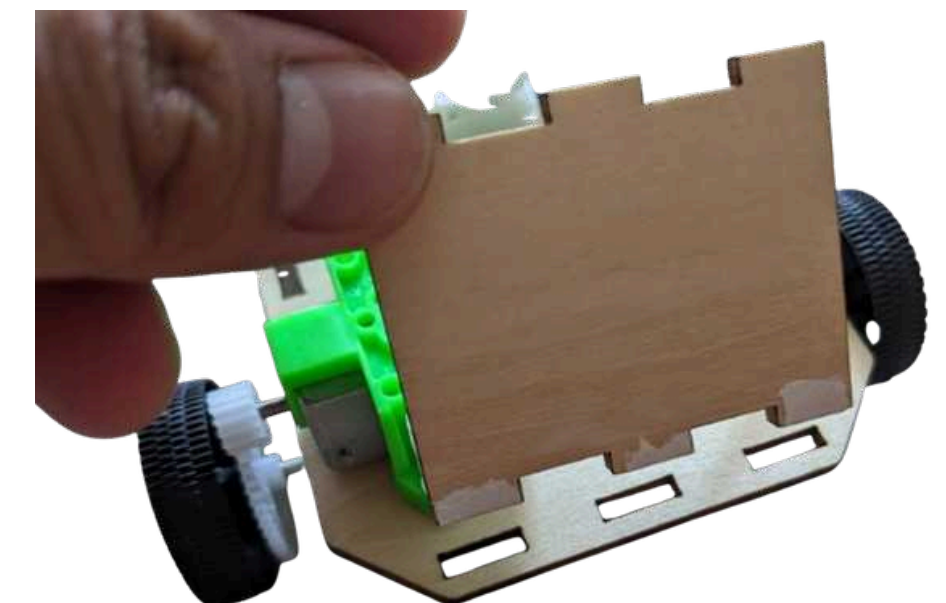



5) Install Body Panels

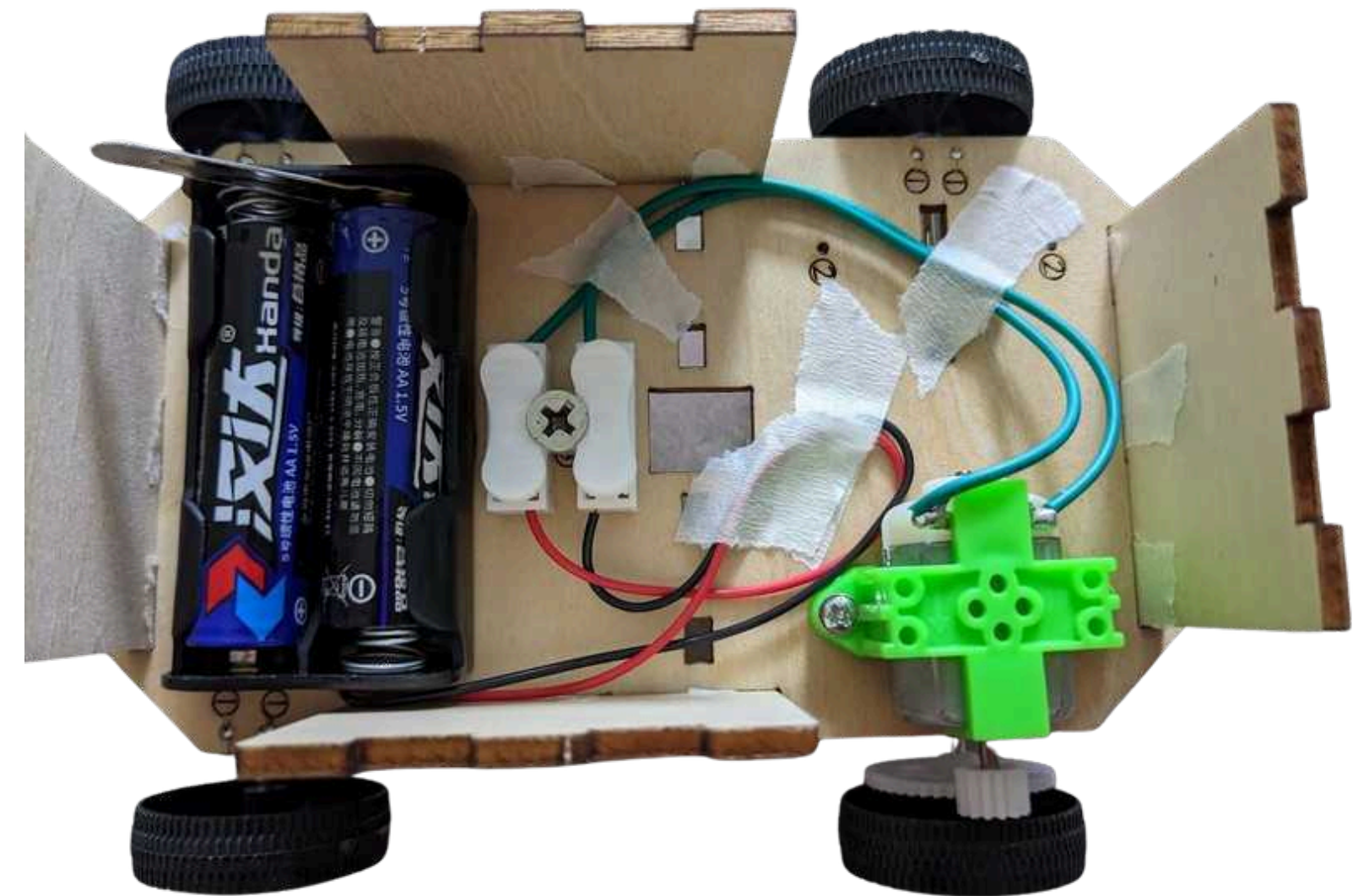

You might want to tape down the wires to make it look nicer!



6) Install Solar Panel

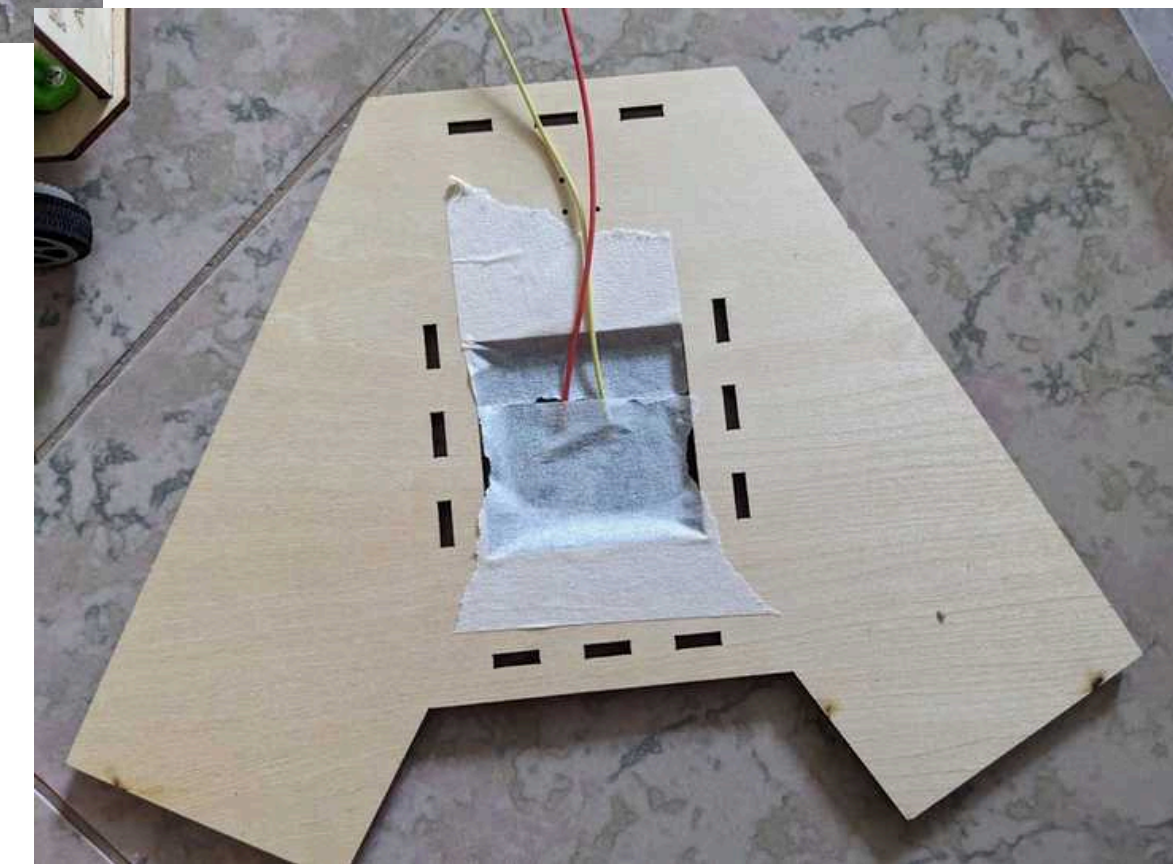
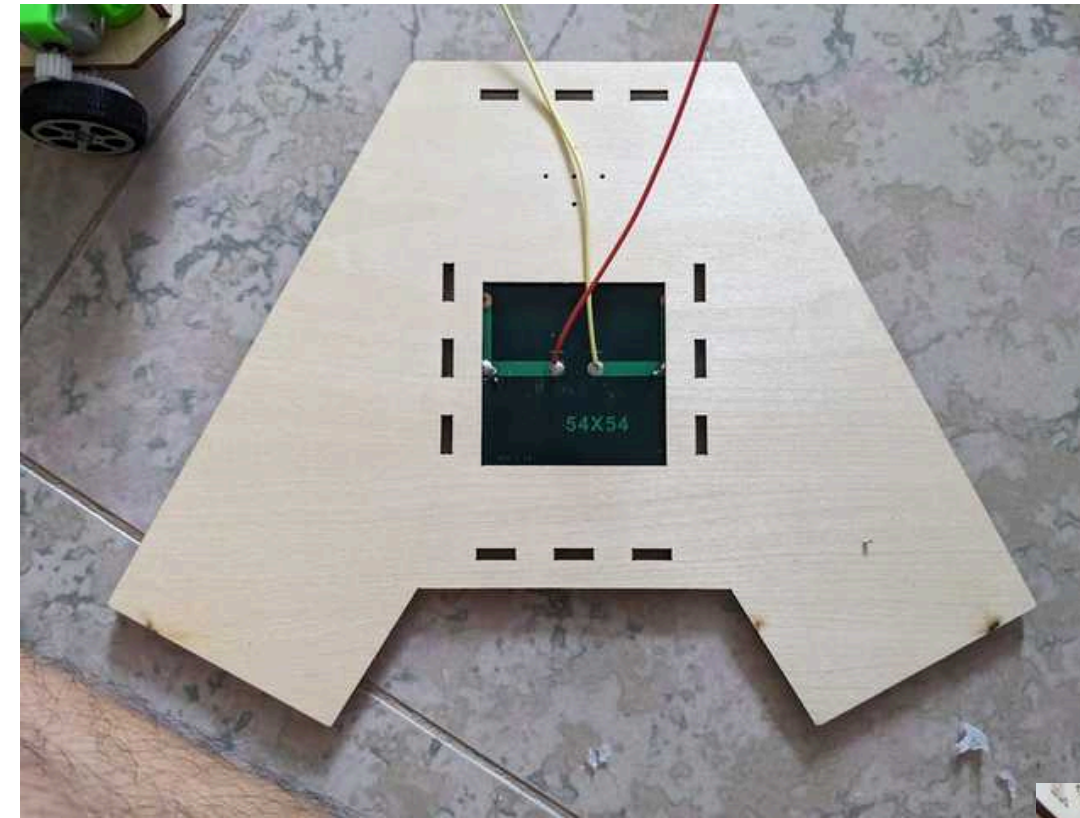
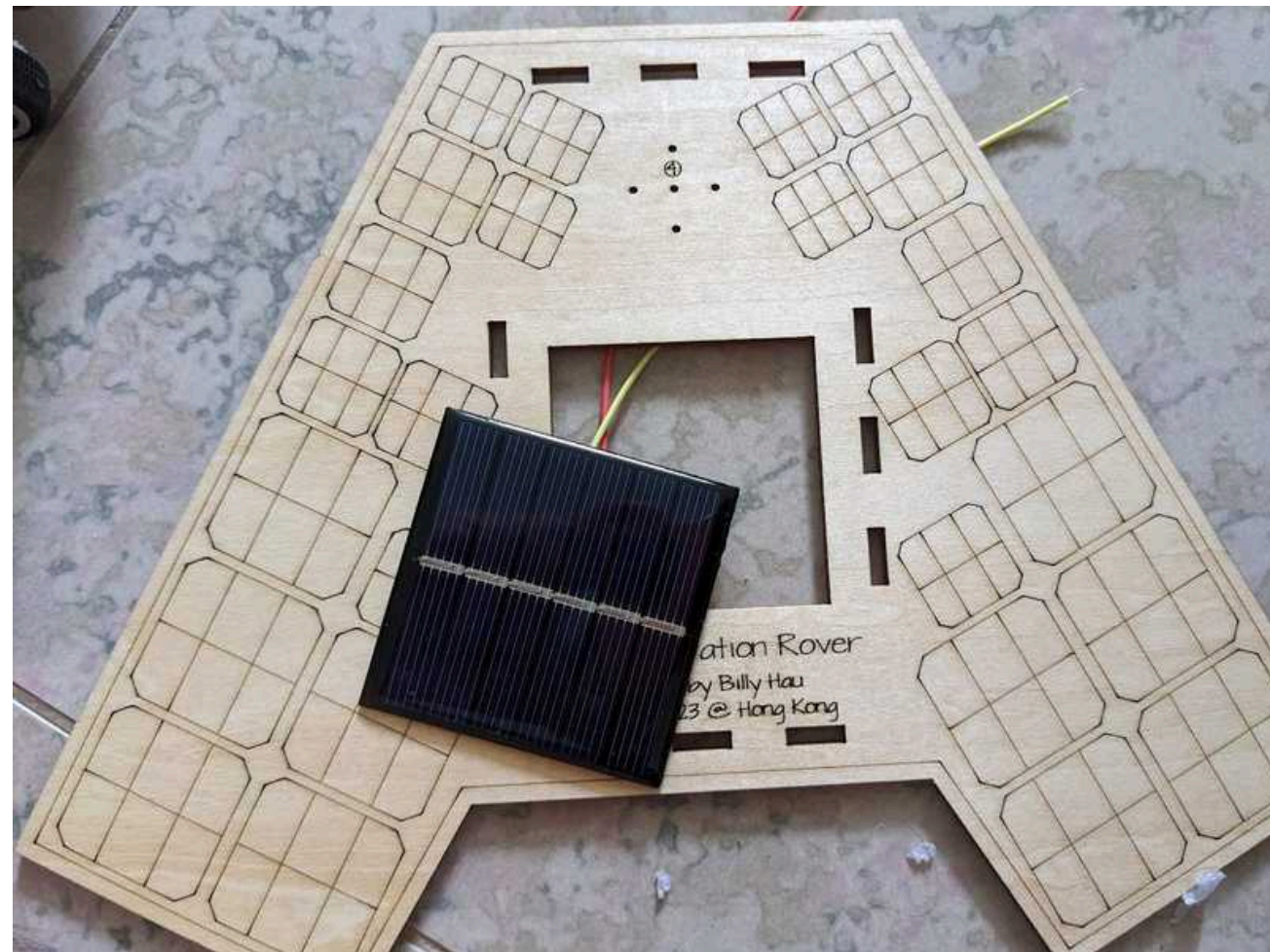

Tape down the Solar Panel, this will provide a secondary power source to our rover!



6) Wire the Solar Panel

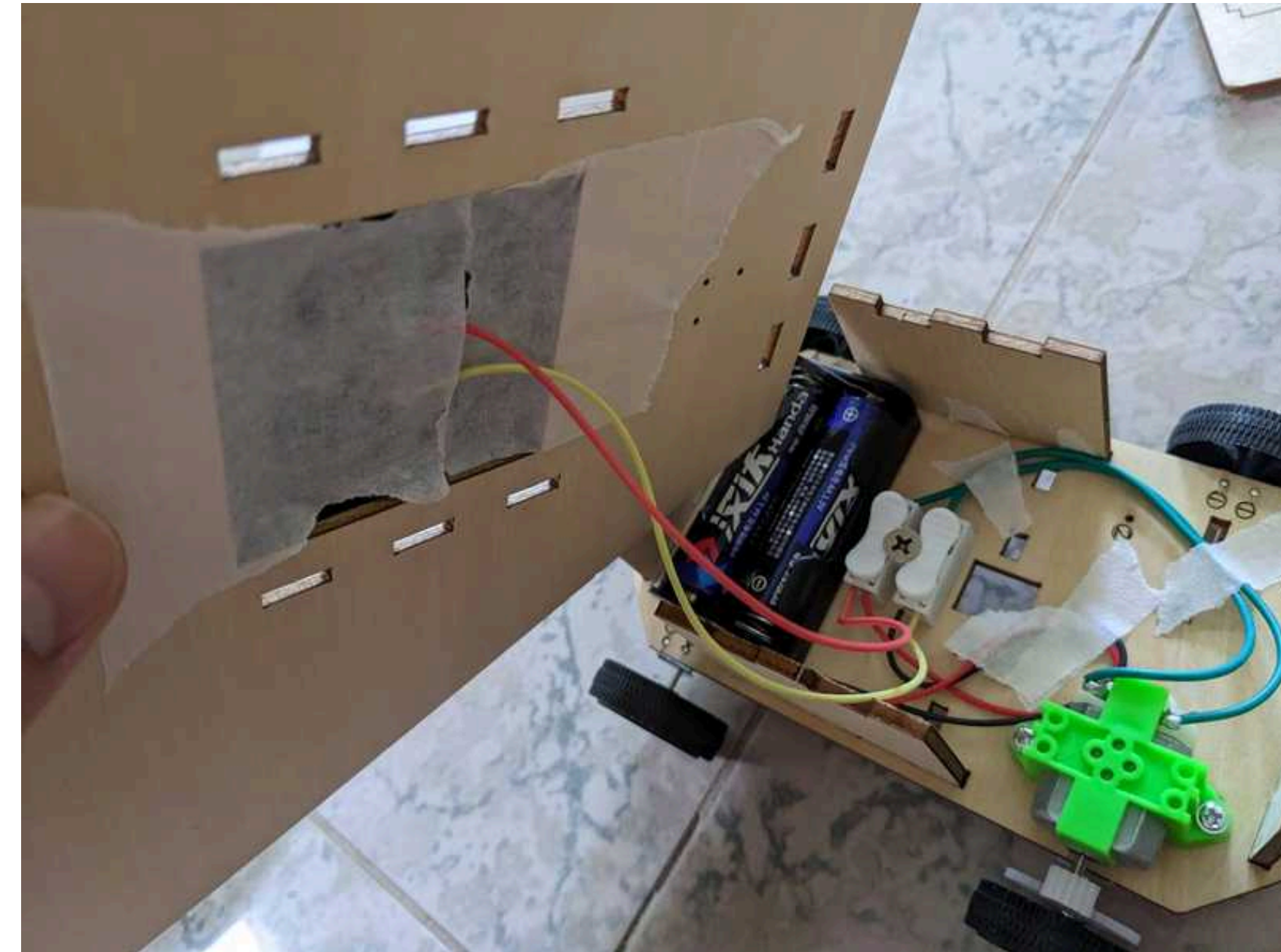
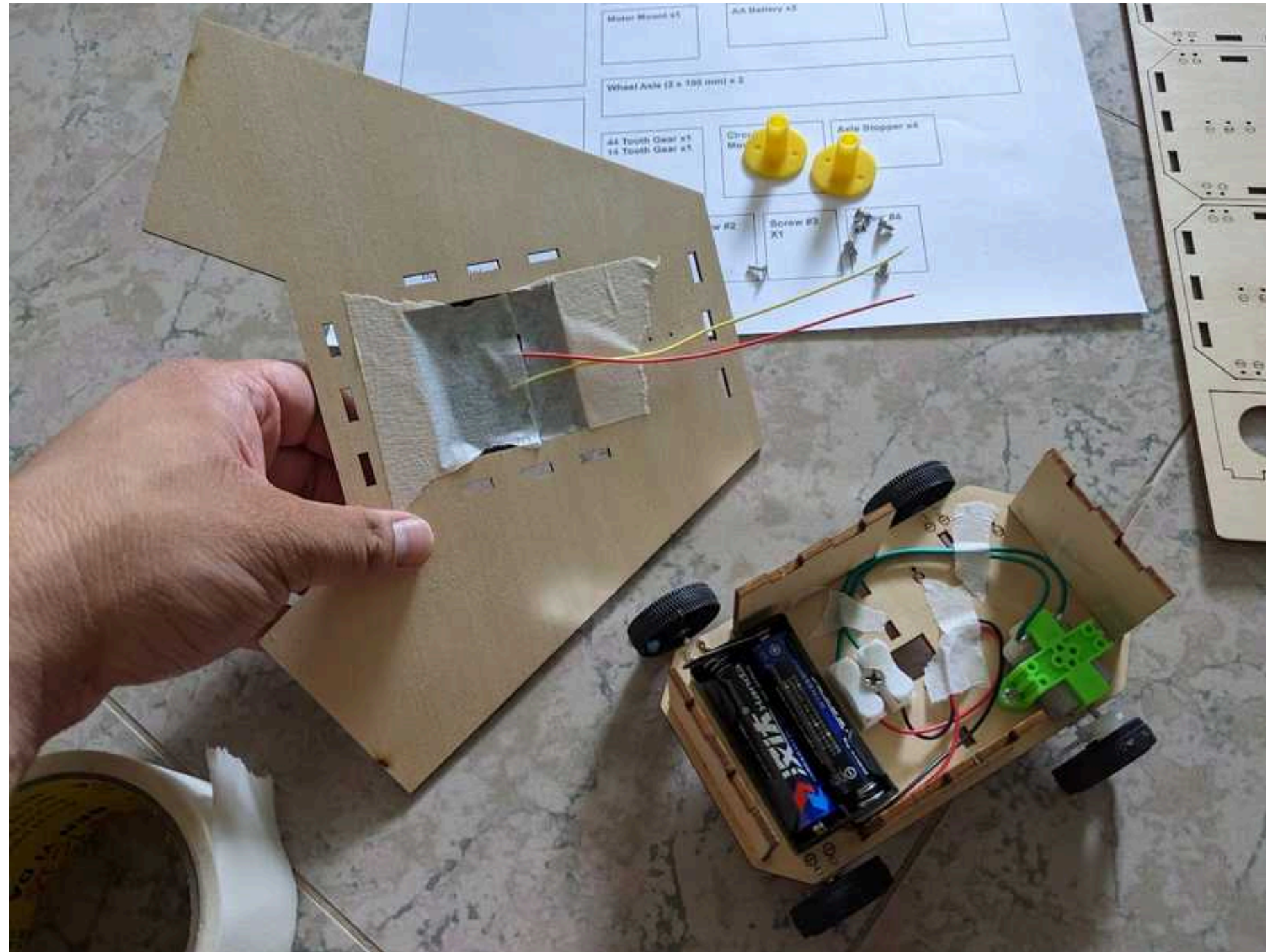

Connect to the battery side, **red to red**,
yellow to black.



6) Install Solar Deck



Install the Solar Deck into the Body Panels. It is easier to do this one side at a time.



7) Install Camera Rod Holder

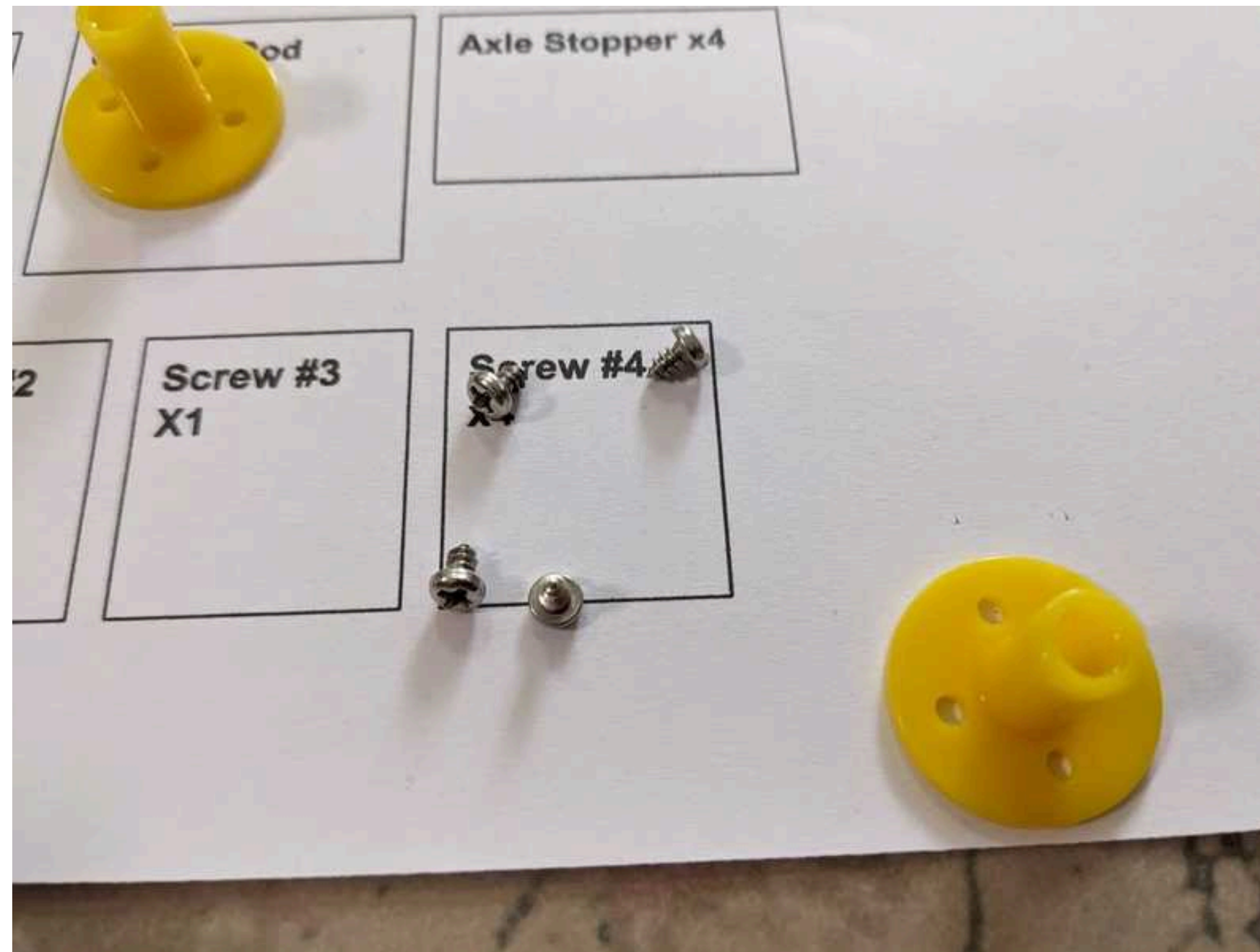



7) Install Camera Rod Holder

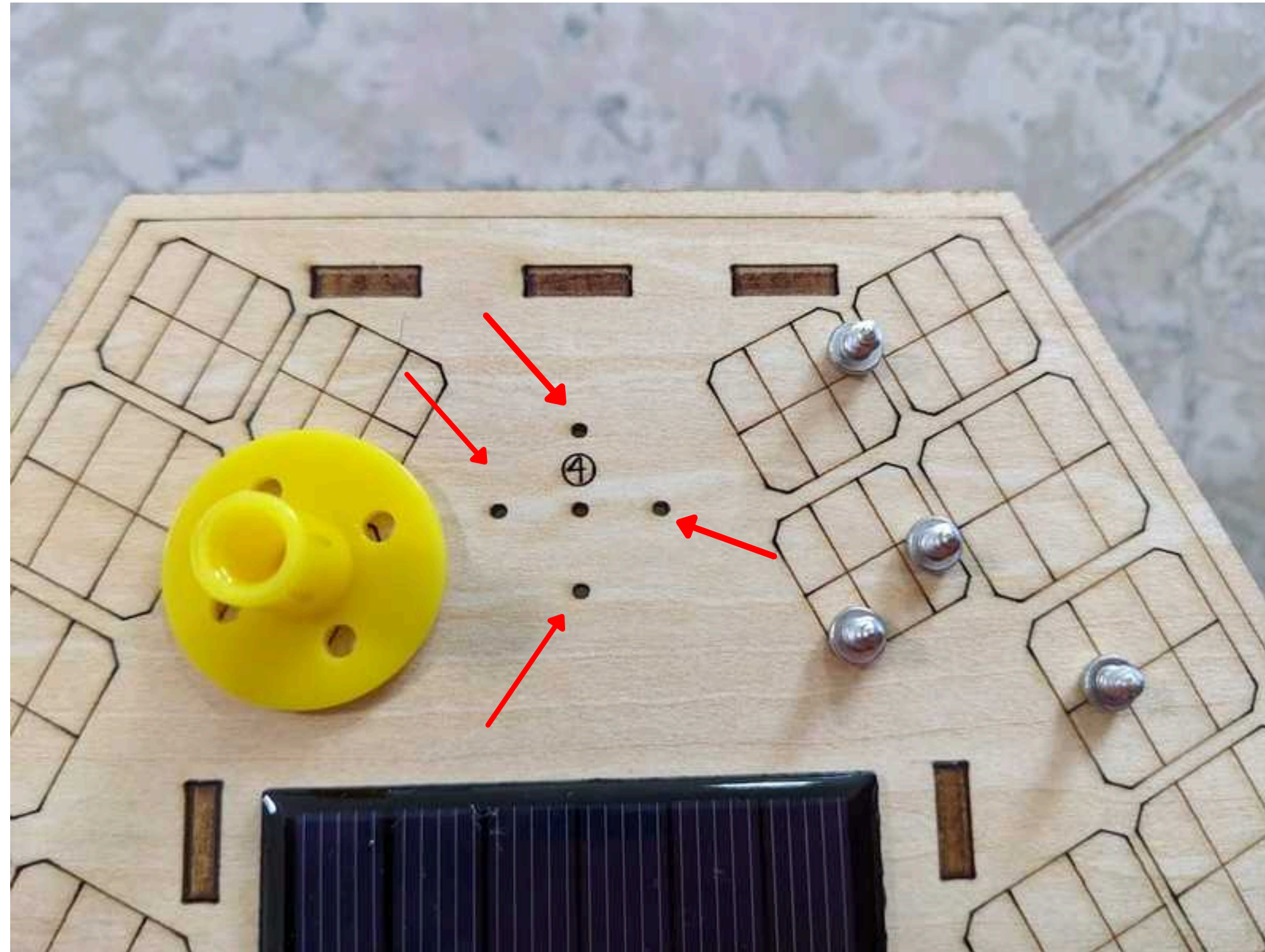



8) Install Camera Holder



9) Test Drive Your Rover!



BILLY HAU
MAKER | GAME DEV | EDUCATOR

